

HOME

Computing

WEEKLY

88

Win!

Space Shuttle from

ACTIVISION



We're giving away 50 games for Spectrum and Commodore

Gallup software chart
The chart to believe in

Stacks of software reviewed for:
BBC, CBM 64, Spectrum, Atari, Electron

Games and utilities to type in for:
BBC, VIC-20, CBM 64, Spectrum, TI-99/4A, ZX81

Now - transform your ZX81 into an electronic organ

Tongue-twisters for the mind
4-D arrays - can you cope?

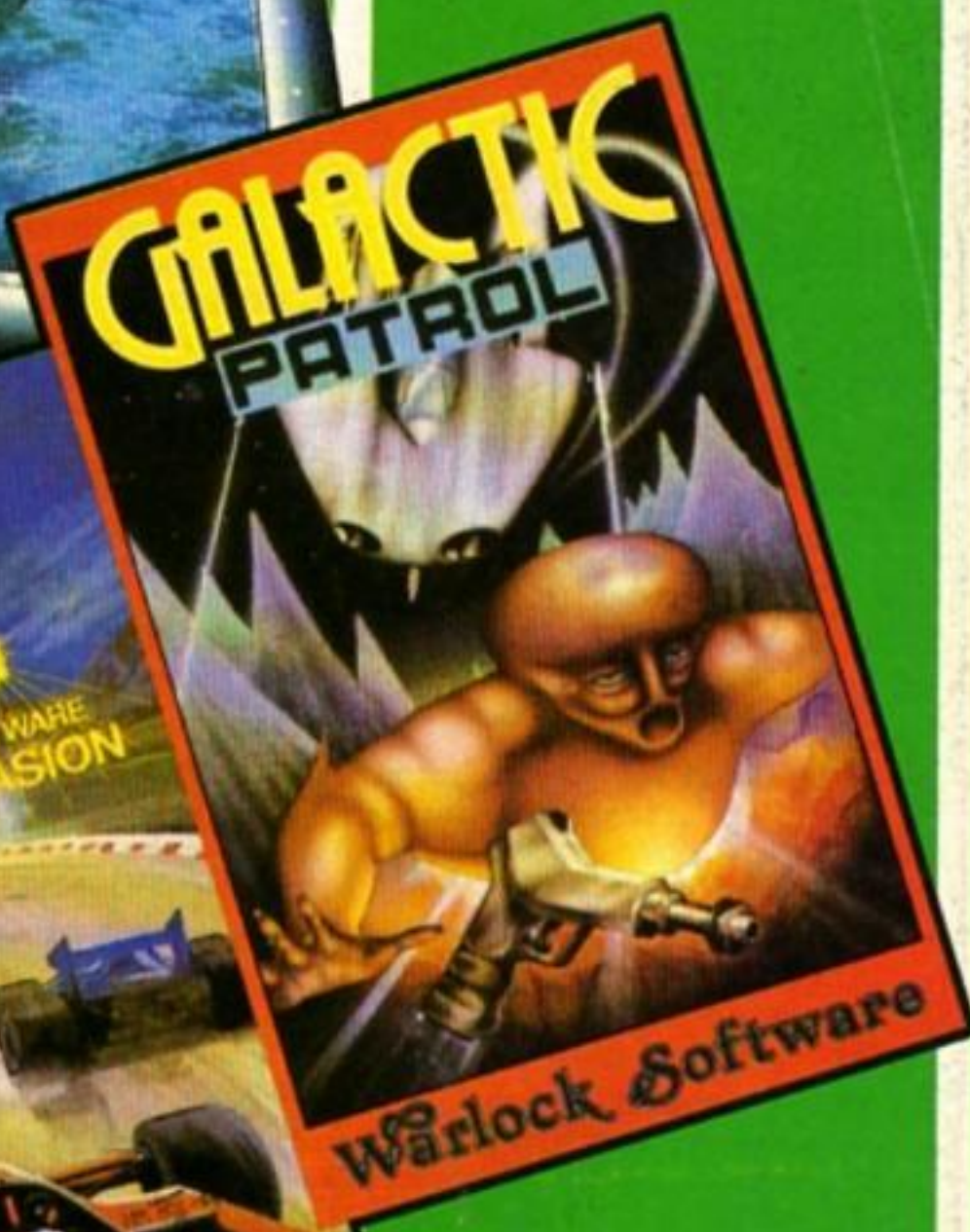
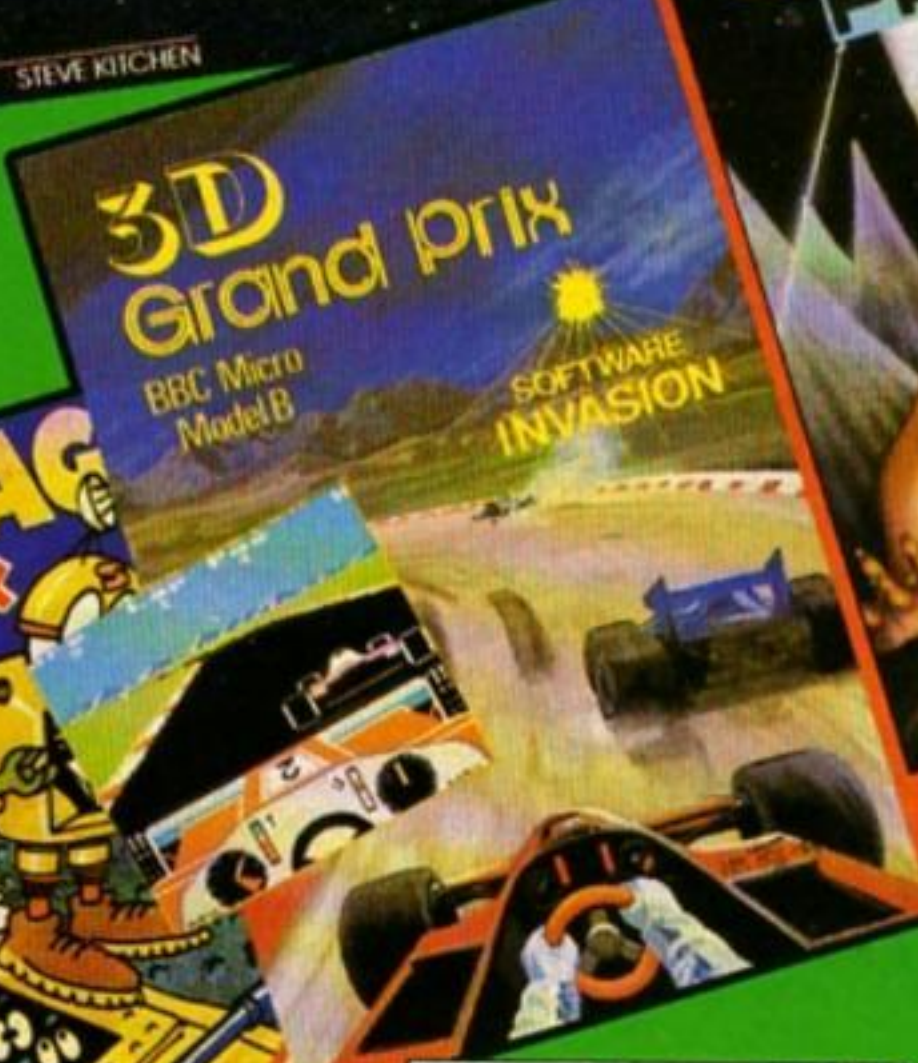

COMMODORE C16 AND PLUS 4

LAS VEGAS

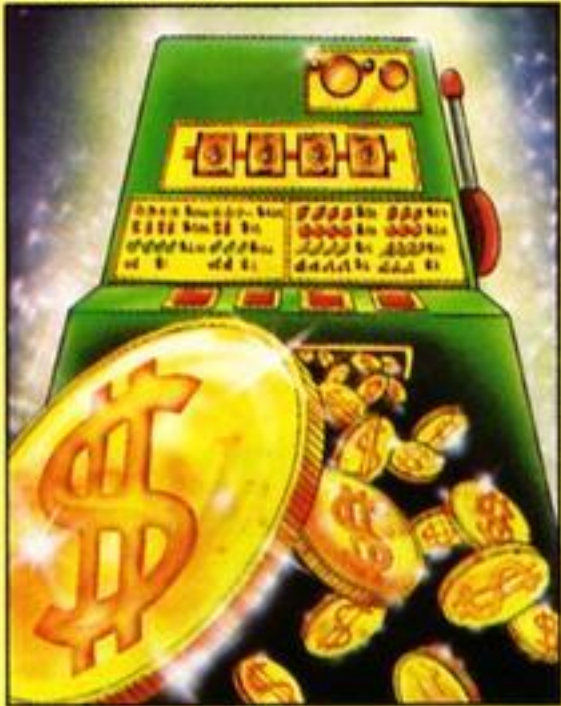

MOON BUGGY

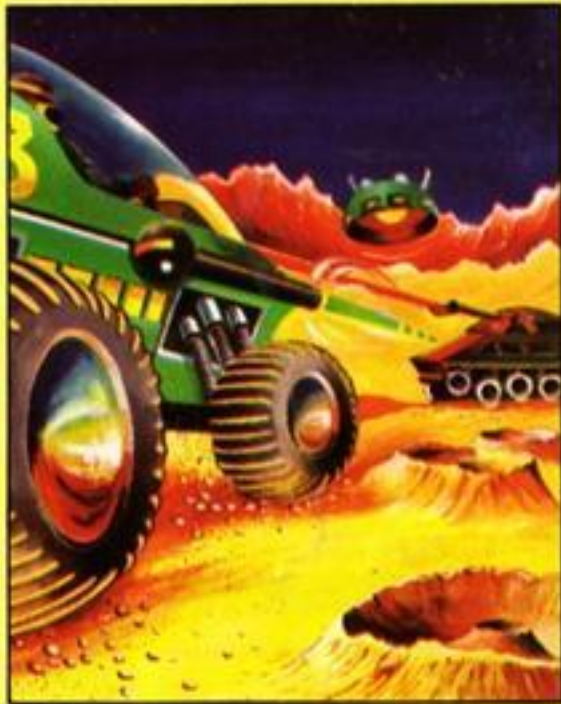

FLIGHT PATH

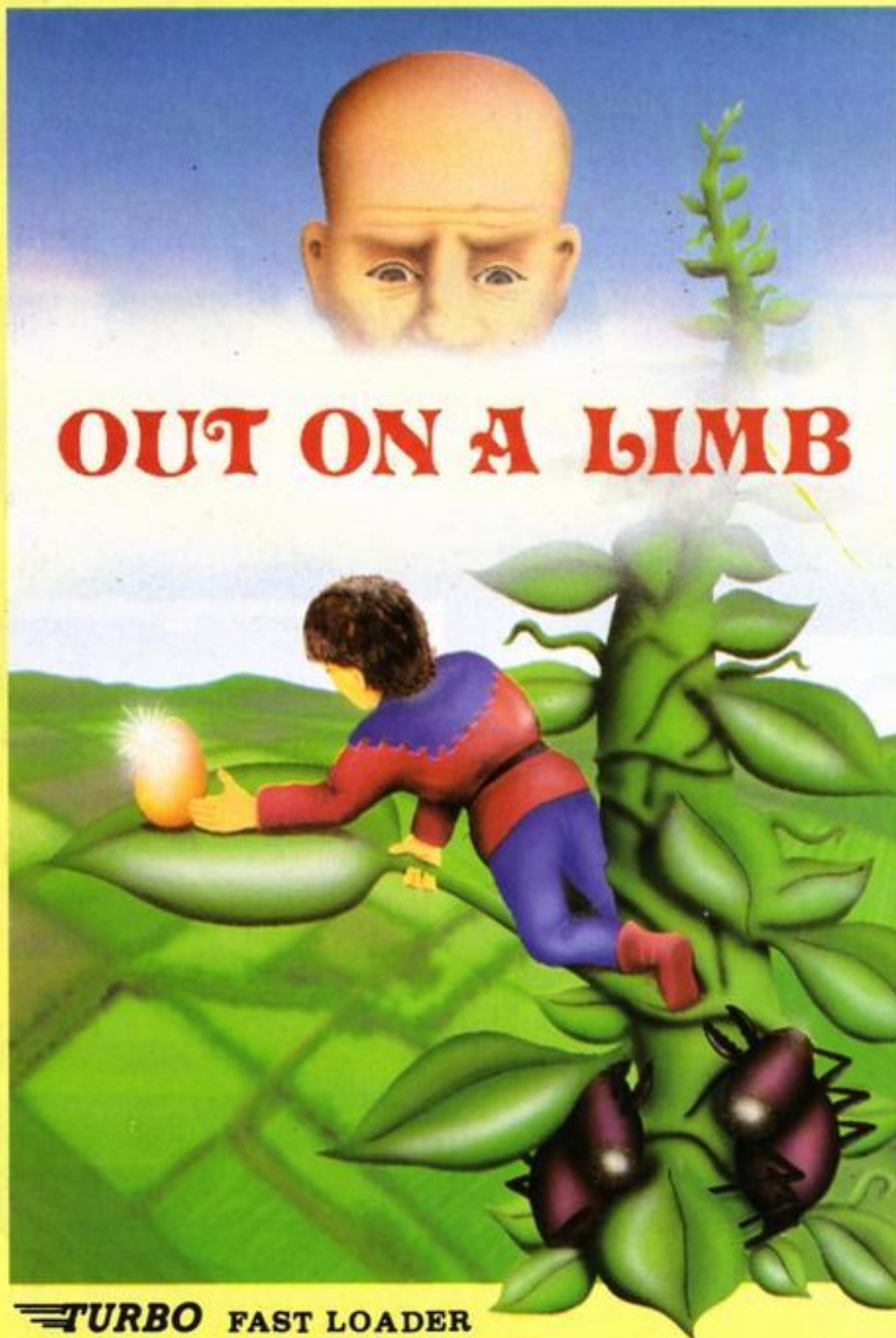
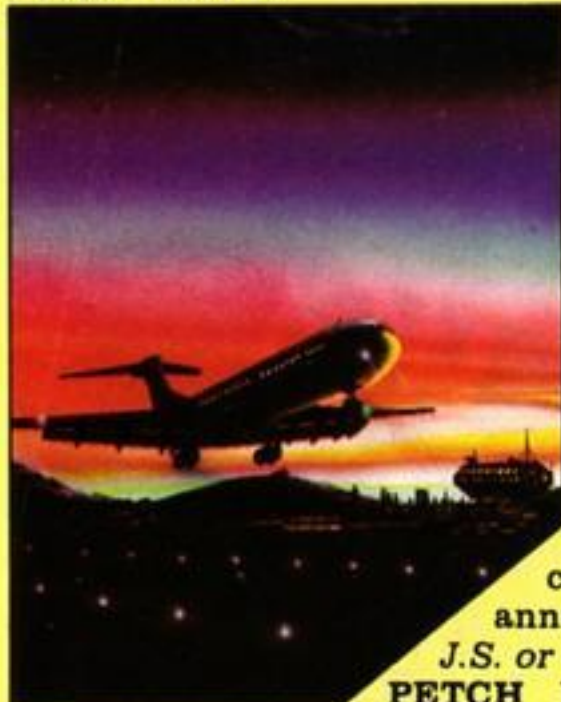

TURBO FAST LOADER

LAS VEGAS Las Vegas brings all the challenges of a deluxe arcade fruit machine direct to your fingertips. Many exciting features include, gamble, cancel, collect, nudge and number options, with a three row display and maximum payout of 20\$.

J.S. or K.B. C.16 £6.95

ZODIAC This is an enthralling arcade adventure in which the evil powers of hell have scattered the signs of the Zodiac in the four hundred chambers of the abyss. Struggle to collect these signs and at the same time try to annihilate everything in your way. How long can you stay alive?

J.S. or K.B. C.16 £6.95

PETCH Race Petch around the screen, moving ice blocks to alter the maze, however, beware of the nasty monsters who are constantly chasing Petch as you attempt to collect the bonus cherries. Also if you can touch the edge of the maze the monsters will suddenly burst into flames, but look out they'll soon be back!

J.S. or K.B. C.16 £6.95

MOON BUGGY You must skillfully manoeuvre your jumping patrol vehicle over dangerous moon craters as well as large boulders and cunningly placed mines. Not only this but avoid the hovering alien spaceship as it bombards you from above.

J.S. or K.B. C.16 £6.95

3D TIME TREK As sole survivor of the planet "Corillian" your quest is one of anger and revenge. The starship you are flying is full of the latest inboard computers and extra powerful sensors. Also included are full 3D graphics, to add unbelievable realism to this fantastic journey through time itself, and beyond.

J.S. and K.B. C.16 £6.95

SKRAMBLE Earth has been overrun by the Cobrons and its up to you to battle through the six ferocious and testing sectors. Adversaries include meteors, UFO's and deadly fireballs. Fly through an armoured city, then an elaborate maze and finally the command base itself.

J.S. or K.B. C.16 £6.95

FLIGHT PATH Flight Path is without doubt the best flight simulator on the C/16 and Amstrad. The many elaborate features include; Altometer, flaps, directional headings, crosswinds, fires, ground warning lights and reverse thrust to name but a few. Also included are smooth graphics as you take off, cruise over mountains, and land once again.

J.S. and K.B. C.16 £6.95

OUT ON A LIMB This is a fantastic and in parts outrageously funny game. Based on the fairytale of Jack and the Beanstalk, Out On A Limb is full of the most strange and eccentric characters you are ever likely to meet. Firstly, climb the stalk and jump onto the clouds, then enter the giant's castle searching for treasures. However, watch out for vacuum cleaners, musical notes, televisions and potted plants, all of which chase you round the many and elaborate rooms of the castle. Once the treasure is collected the single exit will be opened, and then.....?

J.S. or K.B. C.16 £6.95

ANIROG

Mail Order: 8 HIGH STREET HORLEY SURREY 24 HOUR CREDIT SALES HORLEY 02934 6083 Payment by: P.O. - ACCESS - VISA

AVAILABLE FROM YOUR COMPUTER STORE

ZODIAC

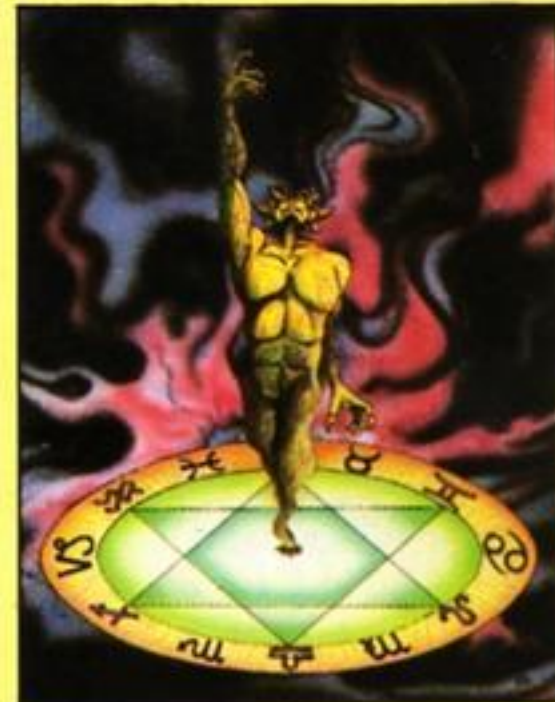

3D TIME TREK



SKRAMBLE



**BUY THIS SPACE
TO ADVERTISE YOUR
LATEST PRODUCTS!
Ring Margaret or Ian
on
01-437 0626. NOW!**

Home Computing WEEKLY

**BUY THIS SPACE
TO ADVERTISE YOUR
LATEST PRODUCTS!
Ring Margaret or Ian
on
01-437 0626. NOW!**

REGULARS

News	5,6
Activision competition	8
Fifty copies of Space Shuttle must be won!	
Letters	44
Classified ads start on	45

SOFTWARE REVIEWS

Ladders and levels	9
Traditional arcade games for the addict	
Careers guide	19
Wondering what to do when you leave school?	
Fun and games	20
Something here for everyone — dip in and come up with a winner	
Beeb bonanza	24
Fairy tales of flight and fantasy	
Fast and furious	31
Arcade action to keep those fingers flying	
Strange worlds	36
Survive in a pond or creep through a crypt	
Wheels and wings	37
Try out difficult forms of transport — you'll be in some sticky situations	
Mind stretching	40
Games to make you think and test your concentration	

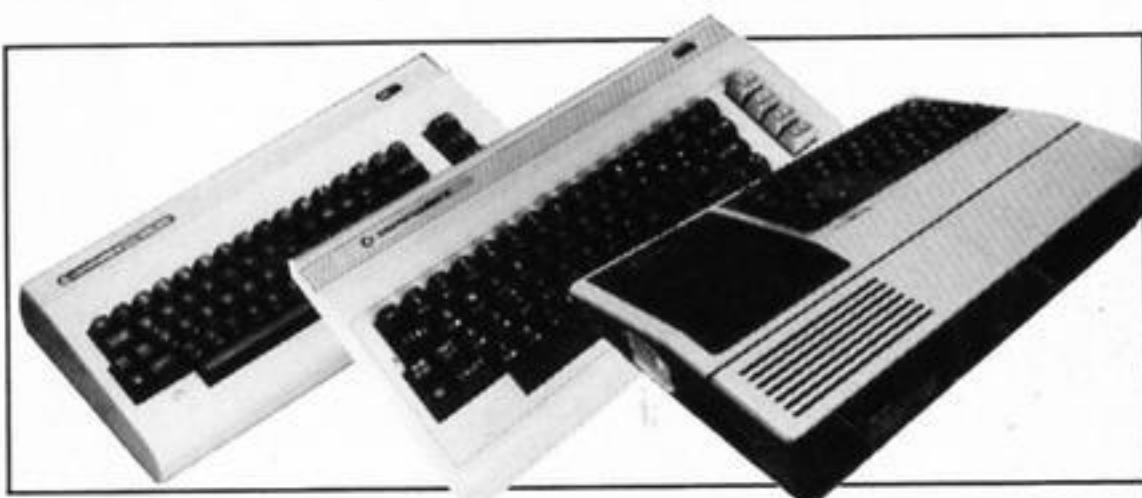

SPECIALS

Ventures	14
Peter Sweasey takes you into the depths of the Underwurld... and beyond	
In-depth analysis	15
Longer length reviews of two of the more expensive utilities around	
ZX81 programming	32
Convert your ZX81 into an electronic storage organ with auto play	
4D arrays	38
Stretch your mental capacities with this tongue-twister for the mind	
Gallup software chart	42
The chart you can believe in	

PROGRAMS

BBC	10
Shingo Sugiura's disassembler should come in really handy	
16K VIC-20	21
Show a flourish for cards in this game of blackjack	
Spectrum	16
A true family game. Find where you buried the bone	
Commodore 64	27
Money is the theme — collect the pounds and get rich quick	
TI-99/4A	34
Beat the computer by knocking the bottles off the wall	

Readers: we welcome your programs, articles and tips.

Software houses: send your software for review to the editorial office at the address below. Contact us for competitions and other promotions, too.

**HOME COMPUTING
WEEKLY
BRITAIN'S BRIGHTEST**

Editor:
Paul Liptrot
Assistant Editor:
Liz Graham
Editorial Assistant:
Marie Curry
Designer:
Bryan Pitchford

Group Editor:
Elspeth Joiner
Production Assistant:
Kerry Fowler

Advertisement Manager:
Margaret Ryan
Sales Executive:
Ian Atkinson

Divisional Advertisement Manager:
Chris Northam
Classified Advertising:
Becki Wilson
Chairman:
Jim Connell

Argus Specialist Publications Ltd.
No.1 Golden Square, London W1R 3AB. 01-437 0626

Home Computing Weekly is published on Tuesdays. Subscriptions and back issues: Infonet Ltd, 10-13 Times House, 179 Marlowes, Hemel Hempstead, Herts HP1 1BB. 0442 48432. Trade distribution: Argus Press Sales and Distribution Ltd, 12-14 Paul Street, London EC2A 4JS. 01-247 8233. Printed by Alabaster Passmore & Sons, Ltd, of London and Maidstone, Kent. Design and origination: MM Design, Circus House, 26 Little Portland Street, London W1N 5AF

48K SINCLAIR ZX SPECTRUM

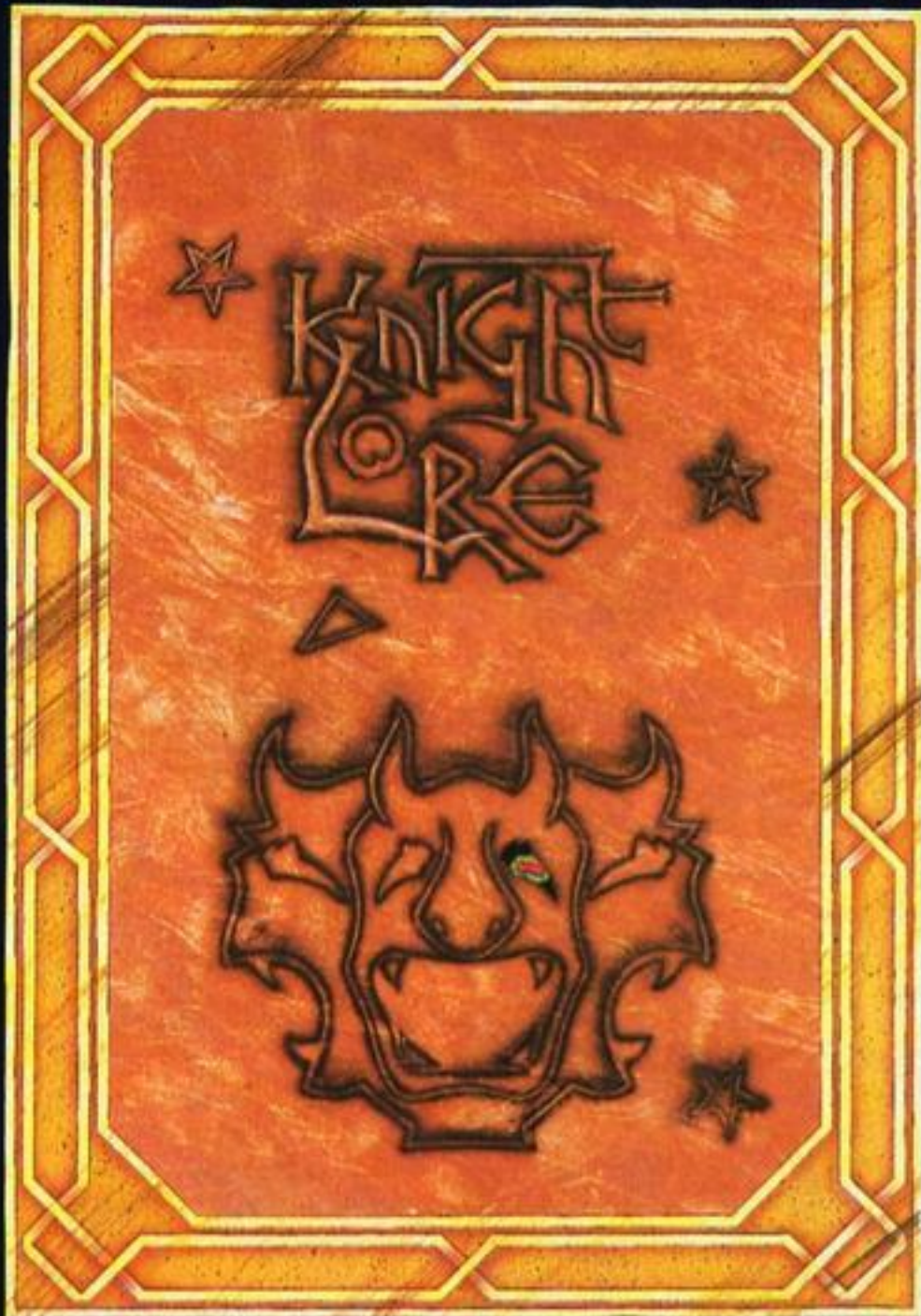

BBC MODEL B 1.2 OS

48K SINCLAIR ZX SPECTRUM

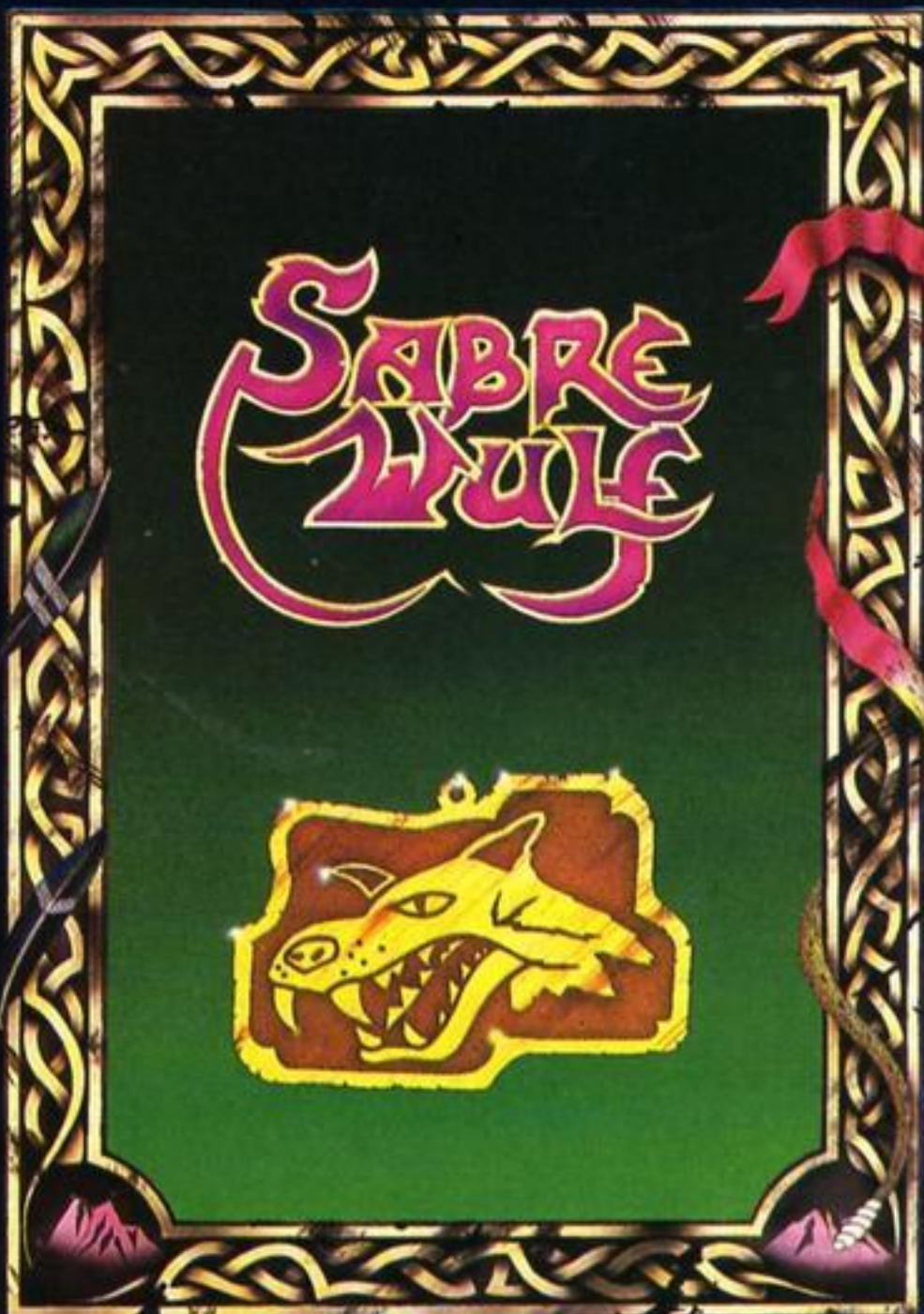

48K SINCLAIR ZX SPECTRUM

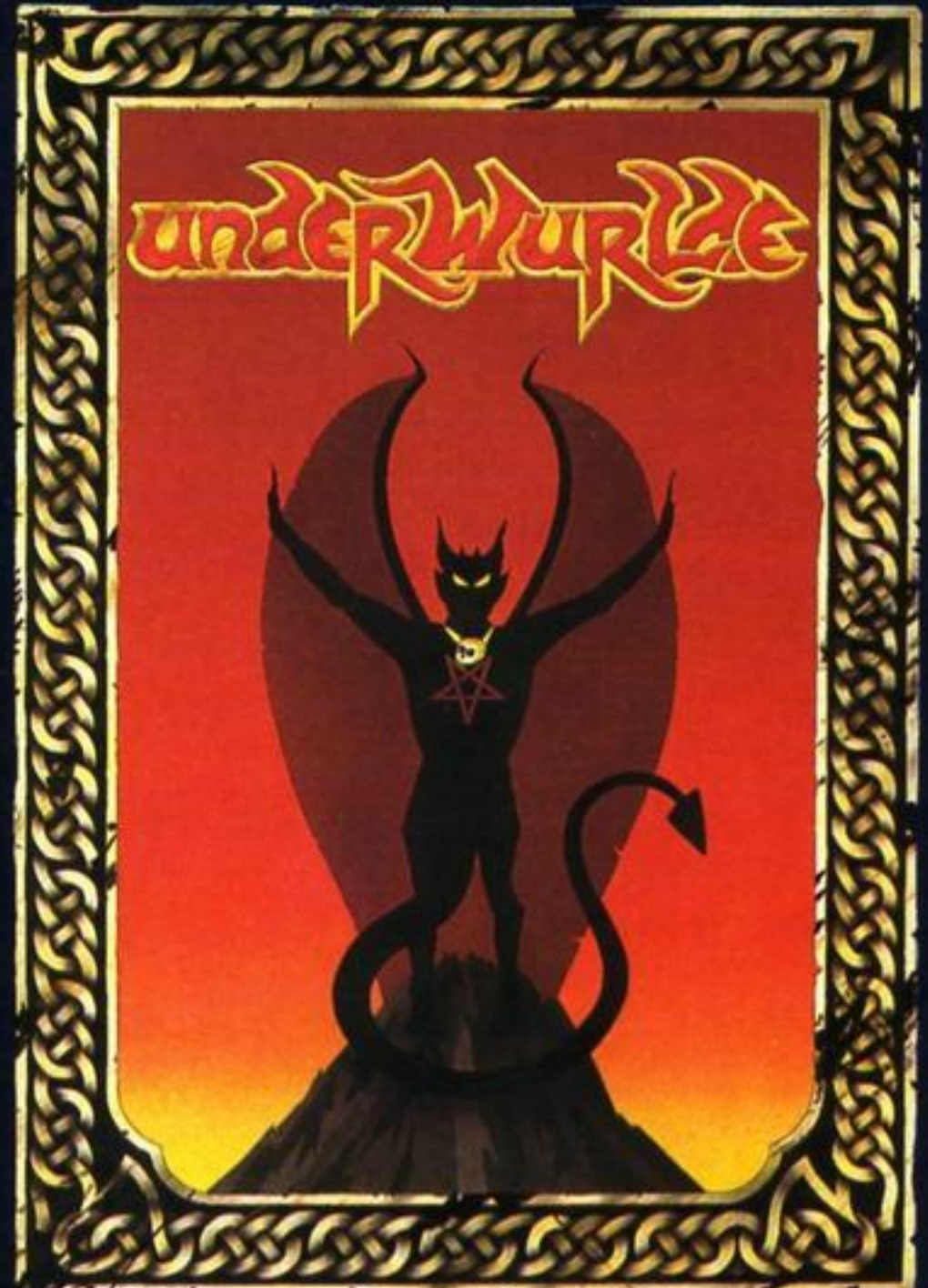

COMMODORE 64

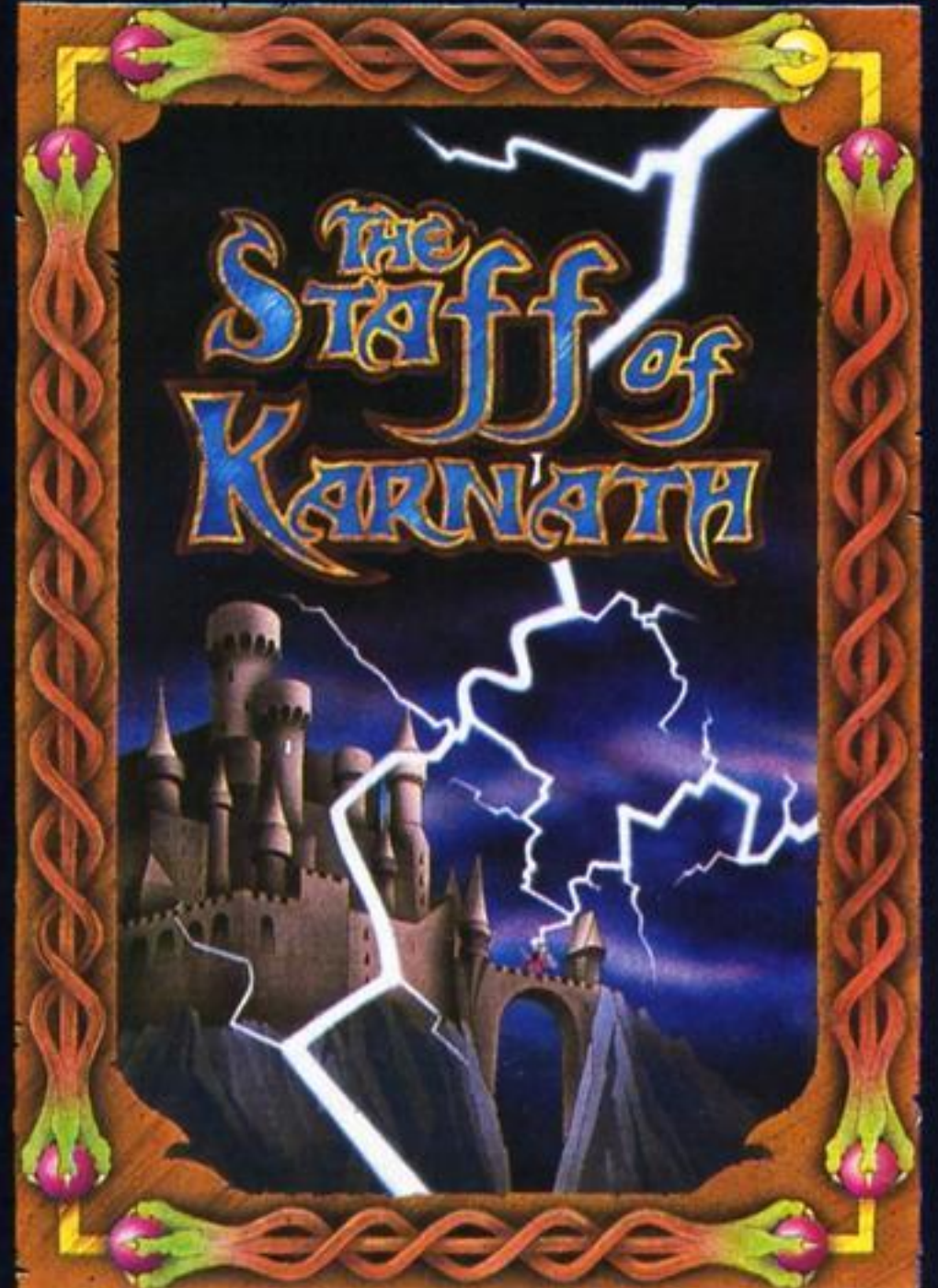

"KNIGHTLORE", "UNDERWURLDE", "SABRE WULF", and "STAFF OF KARNATH" recommended retail price £9.95 inc VAT. Available from W.H.SMITH, BOOTS, J.MENZIES, WOOLWORTHS and all good software retail outlets. Also available from ULTIMATE PLAY THE GAME, The Green, Ashby-de-la-Zouch, Leicestershire LE6 5JU (P&P are included) Tel: 0530 411485

Windfall from Apple?

Serious-minded Commodore 64 users will be interested to learn of the adaption of an Apple package for their machine.

Practicalc costs £69.96 — but incorporates spreadsheet, word processing and database.

Practicorp managing director Colin Aldridge commented: "Practicalc II has the benefits of the most advanced spreadsheets for only a fraction of the cost. We feel that the 64/Practicalc combination offers an unbeatable solution."

Features include 30 maths functions, automatic alphabetic and numeric search and sort, as well as word processing capabilities.

Practicorp, Goddard Road, Whitehouse Ind Est, Ipswich, Suffolk IP1 5NP

Light years on

Beamrider and Pitfall II are now available for the Spectrum from Activision.

Beamrider, at £7.99, is a space game "light years ahead of all other space adventures," according to Activision. Pitfall II (£8.99) stars Pitfall Harry searching for his niece in the lost caverns of the Incas.

Hazards to avoid include electric eels, Amazon frogs, crash-diving condors — not to mention scorpions and bats.

Activision, c/o Ray Hodges Assoc, 5/7 Forlease Road, Maidenhead, Berks SL6 1RP

Santa's star turn

Father Christmas managed to squeeze in a brief visit to Hewson Consultants' launch. He handed out Christmas stockings containing review tapes of Hewson's range of new games.

Hewson Consultants decided to time their launch to catch the post-Christmas boom, which as yet is hoped for but not guaranteed. The theory is that new computer owners will rush out and buy new software — although this year's sales pattern has done nothing to win software houses' confidence.

Andrew Hewson spoke of the caution being exercised by shopkeepers and buyers of software, and explained that, since Hewson owns its own duplicating plant, 1,000 copies

of any particular game can be run off in 48 hours, so over-supply should not be a problem.

The new releases include 3D Lunattack on the Commodore, Fantasia Diamond for the Amstrad and Enterprise, Technician Ted (Spectrum and Amstrad) and Heathrow International ATC for the Amstrad CPC464. This last game features a simulation of Heathrow Airport on one side and Schiphol International Airport on the other side.

Hewson Consultants, 56B Milton Trading Est, Milton, Abingdon, Oxon OX14 4RX

Best of the lot?

English Software has announced the conversion of Colossus Chess 3.0 for Atari 400/800/600XL/800XL by the beginning of February.

Pre-release claims are flowing thick and fast — "It will be the very best chess program, outperforming all the American Atari chess titles," according to the company.

Colossus Chess 3.0 will cost £9.95 on cassette and £12.95 on disc.

English Software, Box 43, Manchester M60 3AD

Laugh and learn

Teach yourself BASIC with a software/book combination from Logic 3. Versions for the Electron and BBC are now available, aimed at complete novices.

And you won't have to plough through yards of computer jargon to understand what's going on, according to Logic 3. The courses are written in plain English, carefully monitored by an educationalist.

"Humorous and highly enjoyable" is how the company describes the series. Each package costs £14.95.

Logic 3, Mountbatten Hse, Victoria St, Windsor SL4 1HE

Fall Guy hiccups

Elite is faced with hiccups over the Fall Guy. Apparently early copies have shown loading problems and the game has now been recalled.

Elite states that this is a result of a turbo program which was supposed to deter copying — not the only thing it deterred, from the sound of it!

Adjustments to the alignment of cassette deck tape heads should rectify this problem, so says Elite, and the company will exchange any cassettes which show persistent loading problems.

You can now buy Spectrum versions of Fall Guy without the turbo load, and without the accompanying loading problems.

The Commodore version should be available in January.

Elite Systems, 55 Bradford St, Walsall

What's in a name?

Legend of the Knucker-Hole is the unusually titled new release from English Software. Jet-Boot Jack is the star character and English Software states that it's a multi-screen arcade game featuring both vertical and horizontal fine-scrolling game play.

Rescuing princesses and fighting dragons are the order of the day. Legend of the Knucker-hole costs £9.95 on Fast-Load cassette for the Commodore 64.

English Software, Box 43, Manchester M60 3AD

Well done, winners

There were 11 differences in our Warwick spot the difference competition. Here are the names of the 50 prizewinners who will each receive four of Warwick's programs for the TI-99/4A.

Richard Green, London; C S Tonge, Portland; Samuel Moore, Woodbridge; J E Fletcher, Buxton; J Cooke, Redruth; Clinton Fern, Helston; G Brewer, Bargoed; Charles McGahey, Hull; Edwin Armstrong, Bedford; John Hollins, Swansea; John Bailey, Ratby; R Bennett, Scarborough; John Knight, Cheltenham; M F Godfrey, Ipswich; B Harris, London; D H Horn, Canterbury; Darren Hawkins, Birmingham; G Cohen, Stockport; Peter Teare, Newcastle; Brian Clegg, Oundle; Diptee Patel, London; John Clark, Oldham; Martin Walker, Hamilton; Tim Prince, Kendal; D Greenwood, Keighley; A J Lofie-Campbell,

Cheltenham; J Tyler, Pontefract; J C Crees, Colchester; David Read, Winsford; Neil Dickinson, Oldham; David Humphreys, Wirral; K W Carr, Rhyll; Graham Sanders, St Helens; G N Lacey, Tunbridge Wells; J Kelly, Hemel Hempstead; P Monaghan, Liverpool; D Paraskevaku, Edinburgh; Paul Clarke, Thetford; S J Phillips, St Albans; Sarah Grant, Harlow; R Roddis, Wembley; J A Kniwands, Liverpool; J Henderson, Brixham; Andrew Walker, Sutton; Robert Cassidy, Richmansworth; K F Wilfor, Chester; Philip Wright, Rochford; Marj Pepperrell, Feltham; William Barker, Washington; M G Poskill, Lindley.

Unique answers

There were 10 mistakes in our Unique spot the difference competition. Eighty winners will receive copies of Jump and Red Attack for the 48K Spectrum.

D E Payne, Taunton; Ivan Adey, Hereford; Philip Dovey, Dartford; Terry Newman, Norwich; H Collings, Aldershot; Dawn Elms, Rochester; P V G Atkins, Lochgilphead; James Prescott, Southampton; Alton Taylor, High Wycombe; L Duff, Scunthorpe; Colin Morton, Bridlington; Don Ramsey, Bradford; A Rahman, Nottingham; B Mawson, Slough; Andrew Phillips, Stafford; L T Lynd-Larsen; Chopwell; J Alba, London; Marcus Prescott, Burton-on-Trent; P Beech, London; K W Carr, Rhyll; K Betteridge, Warley; M Keeton, Doncaster; James Crichton, Renfrew; Lynne Aldridge, Markyates; P Brown, Balerno; D J Tuckfield, South Croydon; Christopher Like, Hay-on-Wye; Craig Harvie, Glasgow; K Holland, BFPO 16; Andrew Norwood, Slough; J A Sitton, Stevenage; Grant Mackie, Leven; Ted Ryan, Nottingham; Karen Stalker, Fraserburgh; Nigel Traves, Warley; Liaquat Ali, Reading; Dave Edwards, Manchester; L Rudd, Birmingham; Ron Banks, London; D R Matless, Norwich; Grahame Chidwick, Grimsby; L Staton, Wakefield; Peter Scouler, Southampton; Lynne Turner, Hull; Glyn Johnson, Halifax; J Cooke, Redruth; Andrew Kelly, Glasgow; W Walker, Stevenage; L Swainston, RAF Wildenrath; Justin Stokes, Willenhall; Ian Lester, Knutsford; Keith Stonehouse, Warrington; P R Taylor, Birmingham; Neil Gawthorpe, Leeds; Tom Cheung, London; P F Goodwin, Dunmow; Amanda Shepherd, Nottingham; Nick Clarke, Leicester; Stephen Pollard, Castle-town; P Cunningham, Skegness; M J Gough, Hersham; Marc Jacob, London; C L Reith, Birmingham; E C Jones, Coventry; G D Allen, Old

NEWS

Harlow; Tim Whitehead, Beverley; J Dedrie, Leyland; Dave Peckham, London; William Barker, Washington; P Hodgkinson, Belfast; Andrew Dalli, London; B D Mumford, W Croydon; R Battams, London; P Kirby, London; John Doyle, Wembley; Robert Winn, Salisbury; Donna De Valmency, Rainham; Tze Hin Cheung, London; Carl Murphy, Liverpool; John Howe, Romford; Greg Richards, London.

Evil Dead winners

There were 11 mistakes in our Evil Dead competition and the ninety winners will each receive a copy of the Evil Dead from Palace Software.

The winners are: A R Cook, S Benfleet; Dennis Gordon, Southampton; Tim Hughes,

Haverfordwest: William Barker, Manchester; D Roebulk, Lymington; Nicolle Nottingham, Hartlepool; Tasos Arnaoutt, Manchester; David Raynard, Bradford; Alan Bell, Pontefract; A J Gale, Worcester; Anne Blair, RAF Wildenrath; A J Logie-Campbell, Cheltenham; R Battams, London; D R Williams, Rochford; M J Gough, Hersham; Robert Compton, Slough; J Woffenden, St Albans; Richard Poston, Horsham; Lam Huyen Le, London; M Bromwich, Deeside; David Somerville, Plymouth; A Summerson, Buckley; G C Brown, Eastbourne; S Stidder, Peterborough; Stephen Brown, Staines; James Lam, London; Eric Howell, Bristol; B Mawson, Slough; A W Todd, Sarratt; Charles Ottaway,

Sheppey; D A Parish, West Wickham; R Abramson, Lowestoft; D R Cook, S Benfleet; Stewart Oakes, Wigan; S F Thomas, North Colerne; Casy Downs, Manchester; Simon Kinns, Bedford; James Lam, London; S Andrew, Swindon; Steven Hurst, Wigan; I R Tinsley, Cardiff; D R Cook, S Benfleet; A R Cook, S Benfleet; N Brazell, Rye; Alexander McNab, Bromley; A Cook, Essex; Stephen Marchant, London; G N Lacey, Tunbridge Wells; Kevin Peckles, Edinburgh; J Austin, Enfield; Mark Graham, Congleton; Paul Coulson, Stamford; Maurice McCann, Portadown; Karl Gaynor, Wolverhampton; Bryan Hower, Gloucester; Alan Griffin, Southport; G Garrow, BFPO 82S; D Hiscock, Chertsey; J C Church, Waltham

Abbey; Proost Danny, Antwerp; John Savage, Seaham; Ted Ryan, Nottingham; Susan Coombes, London; Adam Denby, Alcester; Chris Crane, Trentham; K Austin, Billingham; Stephen Taylor, Bilston; Gordon Dalgarno, Aberdeen; Richard Pattinson, Nairn; Les Evans Telford; Cathy Pitman, Kendal; B Cox, Harrow; E A Tomlinson, Havant; Abdul Wahals, Bristol; Stephen Edwards, Manchester; Peter Scouler, Southampton; Joseph Toomey, London; Steven Eddleston, Blackburn; G Garbutt, Basildon; G G Brown, Washington; D Russell, Warminster; G King, Grimsby; Mark Wiltshire, Surbiton; Simon Luccini, London; D B Sudra, Ilford; K Ceaser, Rotham; Colin Lorton, Bridlington.

BOOKS

Micro library

Sinclair QL

Title: The Working Sinclair QL
Author: David Lawrence
Published by: Sunshine
Price: £6.95

A wide range of programs to realize the full potential of the QL.

Title: Quantum Theory, A Guide to the Sinclair QL
Authors: Jeremy San, Fouad Katan, Simon Rockman
Published by: Century Communications
Price: £5.95

A step by step guide to the QL from when you buy it to when you become an expert programmer.

Title: A QL Compendium
Authors: Martin Gandoff, Robin King
Published by: Addison Wesley
Price: £7.95
Thirty games for the QL, each with a complete listing in Super-BASIC, an introduction and a screenshot.

MSX

Title: The Complete MSX Programmers Guide
Authors: Toshiyuki Sato, Paul Mapstone, Isabella Muriel
Published by: Melbourne House
Price: £14.95
The definitive handbook for the MSX standard computer. Invaluable to beginners and advanced programmers.

Title: MSX Games Book
Author: Andrew Lacey

Published by: Melbourne House
Price: £5.95
MSX games testing reflexes, nerve, logic and intelligence.

Spectrum

Title: Exploring Artificial Intelligence
Author: Tim Hartnell
Published by: Interface
Price: £6.95
This book opens up the fascinating world of artificial intelligence.

Title: Giant Book of Spectrum Arcade Games
Authors: Tim Hartnell, Raymond Blake, Neil Pellinacci, Andrew Turner
Published by: Fontana
Price: £3.95
Fifty incredible arcade programs to turn your Spectrum into the ultimate games machine.

Title: Maths Tutor for the Spectrum
Author: Robert Carter
Published by: Century Communications
Price: £7.95
An introduction to mathematics for the non-mathematical.

Title: Programming Arcade Games for your Spectrum
Author: Adrian Jones
Published by: W Foulsham & Co Ltd
An insight into the workings and production of arcade games in BASIC.

BBC and Electron

Title: Mastering the Electron
Author: John Matthews
Published by: John Wiley & Sons
Price: £5.95

The answers to many essential questions for the newcomer to the Electron.

Title: Micro Mates — six-part book series
Author: Jonathan Inglis
Published by: Granada Publishing
Price: £1.95 each
Shapes and pictures, music and sound effects, words and word games, maths tables and numbers, movement and animation and facts and figures are the topics covered in this series.

Title: Advanced Programming Guide to the BBC Micro
Author: Jeremy Ruston
Published by: Interface
Price: £7.95
A complete tutorial on advanced programming for the BBC.

Title: Book of Computer Games
Author: Simon Dally
Published by: Century Communications
Price: £3.95
Puzzles for Acorn computers. An excellent way of acquiring programming skills.

Title: Electron Micro Guide
Author: Peter Morse, Brian Hancock
Published by: Century Com-

munications

Price: £1.99

A conveniently sized, clearly laid out reference guide for the Electron owner.

Amstrad CPC464

Title: Dynamic Games for the Amstrad
Author: Clive Gifford
Published by: Interface
Price: £5.95
An exciting collection of games for you and your Amstrad.

Title: Machine Code for Beginners on the Amstrad
Author: Steve Kramer
Published by: Micro Press
Price: £6.95
Beginners machine code on the CPC464.

Title: BASIC Programming on the Amstrad
Author: Wynford James
Published by: Micro Press
Price: £7.95
Programming for the complete beginner, introducing the majority of commands available on the Amstrad.

Title: The Amstrad CPC464 Advanced User Guide
Author: Mark Harrison
Published by: Sigma Press
Price: £6.95
Contains 40 programs ready-to-run on the 464 ranging from the simple to the challenging.

General

Title: Data Log
Authors: Roger Porkess, Derek Barker, Nigel Green, Peter Johnson, Colin Shearer
Published by: Collins
Price: £2.95
First readers for BBC, Spectrum, Electron and CBM 64. Set around a space theme, the programs take the form of a work book.

WORDSWORTH[©]

THE GAME FOR ALL THE FAMILY

BASED ON THE POPULAR "FIND THE WORD" GAME
A REAL TEASER AND CHALLENGE FOR
PLAYERS OF ALL AGES.

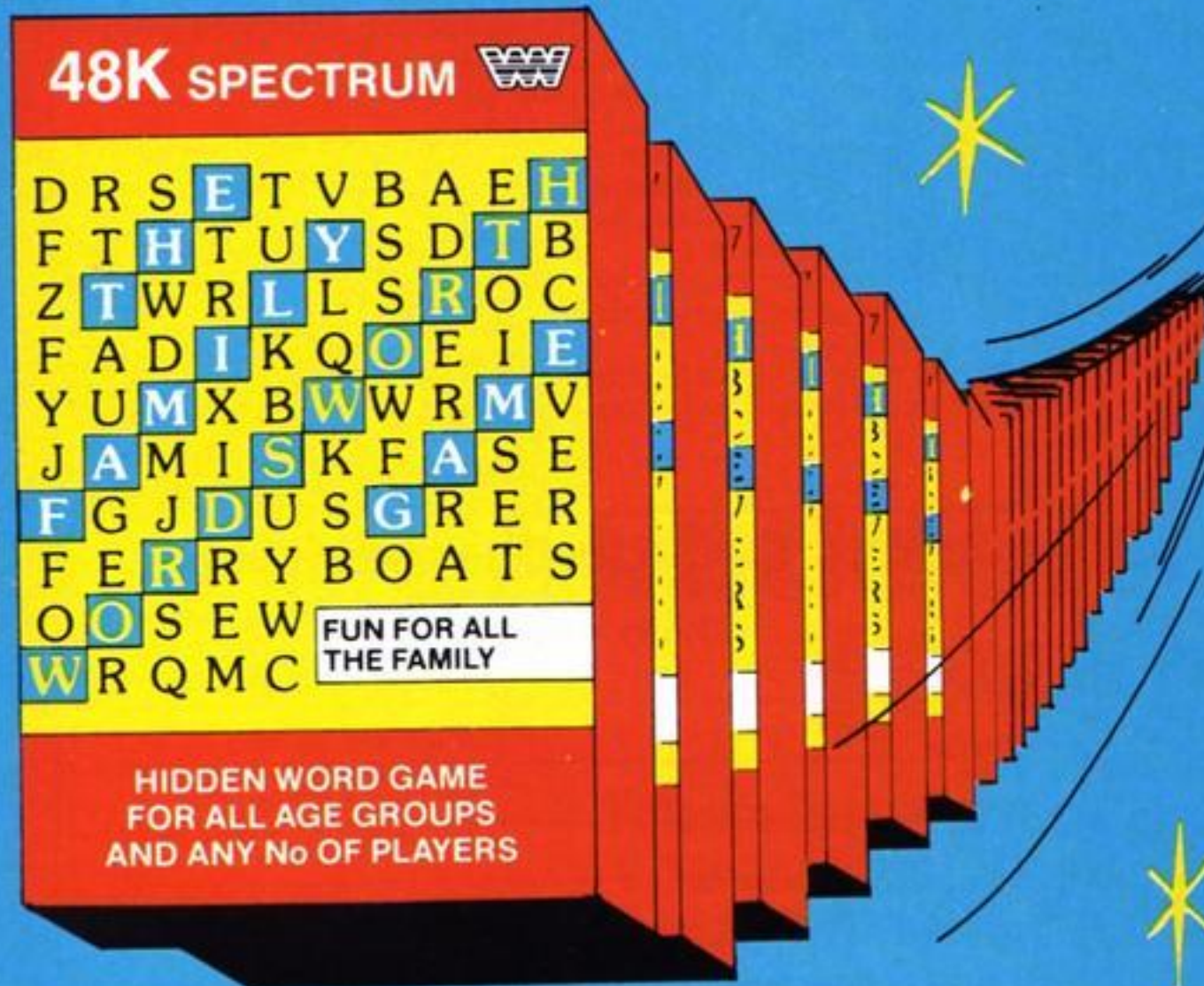

Any number of players can join in.

Words are hidden in all directions they can also link up or cross each other too!

Play computers words or your own!

Try to beat the computer at competition level!

Nursery rhymes, proverbs, sayings can be used - even foreign words - Wordsworth[©] can cope.

- ★ 26 levels of play
- ★ Up to 30 words can be used in any game
- ★ Endless hrs. of enjoyment
- ★ Easy to read re-defined characters
- ★ Helps children spell
- ★ Use computers words
- ★ A game for all ages
- ★ Competition level
- ★ Every game a new challenge

WORDSWORTH[©] is available by Mail Order from:-

Wordsworth Software Ltd
P.O. Box 304, Reading, Berks RG2 0RH



SPECIAL OFFER

Buying Wordsworth as a gift?
Customers will be sent Wordsworth[©]
Gift wrapped with label - please tick
gift wrapped box on coupon.

ONLY
5.95
FOR THE 48K
SPECTRUM



To Wordsworth Software Ltd., P.O. Box 304,
Reading, Berks. RG2 0RH.
(BLOCK CAPITALS PLEASE)

Please rush me copy(ies)
of Wordsworth[©] @ £5.95 each

Gift Wrapped

I enclose Cheque/Postal Order for
£ : Payable to Wordsworth Software Ltd.

Name:

Address:

.....

.....

Post code:

50 readers must win a fantasy trip into space in Space Shuttle Activision's

We have lift off!

MOST PEOPLE cherish the hope that one day they'll be able to soar above the earth and experience the marvellous sensation of space flight. Unfortunately this can often seem like an impossible dream.

This week by way of compensation we're offering 50 readers the chance to launch themselves into this amazing star-studded world. Activision's new title Space Shuttle is the game that's on offer in our latest competition. It runs on the 48K Spectrum (£7.99) and the CBM 64 (£9.99).

As the name implies, the game is based upon the US space shuttles which have been making headlines all over the world. Activision claims that the program gives the user a chance to learn some of the secrets of the operation of the real space shuttles.

You are the pilot and you have a very complex mission. There are six stages in your flight and to complete your mission you must achieve success in all of them.

It is mission 101 of the Space Transportation System and you command the famous space shuttle Discovery. Your objective is to reach an orbiting satellite 210 nautical miles above the surface of the earth. The satellite

has intentionally programmed gyroscope problems, making your task very complex.

You must launch your craft and rendezvous and dock with the satellite as many times as you can. Then you must return safely to earth. There are two things to bear in mind while you're so many miles from home: firstly, fuel is like gold-dust (there aren't any petrol pumps in space!), and, secondly, every time you dock with the satellite it has been programmed to become more erratic.

There are two training modes so you can build up your confidence before attempting a fully fledged shuttle flight. Activision's claims this is quite realistic and you receive an evaluation at the end of your flight.

Steve Kitchen, the author, is a software designer, engineer and inventor. He was involved in the development of digital watches, and the first hand-held electronic games and calculators.

He has been fascinated by the Space Program for many years, so, if you want to join him in his fantasy trip into the sky, put pen to paper and send us your entry now!

We've compiled a wordsquare of hidden Activision game titles. Put your head down and puzzle them out. You could be commanding the 101st mission of space shuttle Discovery.

Activision Titles

- Designer's Pencil
- Toy Bizarre
- Beamrider
- Pitfall
- Space Shuttle
- Ghostbusters
- Hero
- Decathlon

How to enter

Study the wordsquare and mark all the Activision titles you find with a ball-point or semi-opaque felt tip pen. Complete the coupon clearly and fully — if you are a winner it will be used as a label. Send the wordsquare and coupon to us.

Important: write the number of Activision titles you found on the back of the envelope.

Send your entry to: Space Shuttle Competition, Home Computing

Weekly, No. 1 Golden Square, London W1R 3AB. Closing date is at first post on Friday January 25, 1985.

You may enter as many times as you wish, but each entry must be on an official coupon — not a copy — and sealed in a separate envelope.

Prizes will arrive from Activision within 28 days of the publication of the issue containing the results of the competition.

The rules

Entries will not be accepted from employees of Argus Specialist Publications, Activision and Alabaster Passmore & Sons. This restriction also applies to employees' families and agents of the companies.

The How to Enter section forms part of the rules.

Space Shuttle Competition

Entry Coupon

Name _____

Address _____

_____ post code _____

Number of titles found _____

Type of computer _____

Complete clearly and fully — if you are a winner this will act as a label for your prize. Post to Space Shuttle Competition, Home Computing Weekly, No.1 Golden Square, London W1R 3AB. Closing date: first post, Friday January 25, 1985. Don't forget to follow closely the advice in the How to Enter section, including writing the number of titles found on the back of your envelope.

A	D	B	A	S	I	T	Q	K	H	R	U	W	T	O	C
R	C	P	L	S	L	V	R	G	I	T	B	P	Q	L	S
J	S	P	A	C	E	S	H	U	T	T	L	E	I	I	S
Q	V	I	T	V	M	I	S	N	D	I	L	C	V	E	R
R	O	T	U	N	C	B	O	D	I	R	N	T	U	L	M
O	M	F	B	E	A	M	R	I	D	E	R	T	R	J	I
U	L	A	I	J	L	R	A	B	P	C	C	S	L	A	C
L	I	L	B	N	I	D	B	S	V	I	S	N	P	B	E
P	E	L	G	K	N	I	R	H	D	L	A	O	R	M	A
M	V	U	R	M	R	E	L	N	L	D	B	R	S	H	O
N	Z	U	L	R	N	D	O	R	P	T	G	K	O	E	U
I	Z	I	L	G	H	O	S	T	B	U	S	T	E	R	S
L	Q	N	I	J	R	S	T	B	U	V	T	L	N	O	L
T	R	S	N	L	E	B	A	A	A	K	I	V	E	B	I
R	E	G	H	U	S	I	P	L	Q	J	N	P	A	I	R
D	L	O	S	B	R	J	Q	V	L	N	N	O	O	N	M



Beebul 48K Spectrum £1.99

Scorpio Gamesworld, 307-313
Corn Exchange, Manchester

Mastertronic and Power have proved that there's good value for money from a £1.99 game, Scorpio confirms it. True, you don't get joystick control, but you do get a well executed game of the best machine-code and BASIC mixture often found in magazine listings. You don't, of course have to spend 10 hours typing it in!

Beebul, a bovine creature sits atop a selection of platforms on which a variety of thingies twist and turn. You must deduce the best way of collecting objects whilst avoiding the aliens. When you reach the bottom, a teleport is available back to the top.

Collect the lot, and another screen is revealed which is much the same only harder.

Graphics are smooth and flicker free, but not animated. The keys for control have been well selected and the game is fun. It may never become the talking point of computer buffs, but will certainly go down well with the younger members of the family as it's not too difficult. A good stocking-filler at a modest price.

D.M.

instructions	100%
playability	100%
graphics	70%
value for money	100%



Fahrenheit 3000 48K Spectrum £5.95

Softstone Limited

I have to admit that I have seen just about as many ladder and level type games as I can stand. This is yet another and although there is plenty of variety, there are 64 screens, and the graphics are acceptable, it has nothing new or original to recommend.

It follows the usual format. you are collecting, sorry 'turning off', a number of valves in order to shut down a nuclear reactor that is in a Meltdown situation. There are plenty of the usual hazards to thwart you in your task, including barriers to jump over and stairs to climb. As I said earlier, the graphics are reasonable but in no way can they be

described as special.

The only difference that I have found between this game and the usual versions is that there is no fixed number of lives after which the game ends. Instead there is a fixed time limit after which the reactor blows its top off, or should I say bottom out, and the game ends in a suitably cataclysmic manner.

D.C.

instructions	25%
playability	50%
graphics	45%
value for money	25%



Smash & Grab Electron £7.95

Superior, Regent Hse, Skinner
Lane, Leeds 7

This is another conversion from the fast BBC machine to its slower brother and I have to say that the original speed has been well maintained. Of all the ladder and level games I have seen, this is one of the most interesting variations mainly because of the range of movement the policeman exhibits.

He will jump on you, prod you on the back and even fall flat on his face so he can beat you around the head when you're below. All this just to prove that crime doesn't pay!

You try to collect bags of gold that showered out of the bank after you kicked a police cone through the window.

There are ladders to climb, police boxes to kick and even flying police cones that make you life rather transitory. The screens show enough variation to prevent the game becoming boring and pedestrian. As usual with superior products the graphics are excellent, with a good use of colour and no flicker. I expect this game will have you rolling with laughter, I certainly did.

D.C.

instructions	95%
playability	95%
graphics	100%
value for money	100%



Ladders and levels

Traditional arcade games for
the addict. There's hours of
enjoyment on this page

Zany Kong Junior Electron £7.95

Superior, Regent Hse, Skinner
Lane, Leeds 7

This one is obviously meant to appeal to the Crazy Kong fanatics for it depicts the antics of his younger brother. Based on the ubiquitous ladders and levels format, junior is trying to get to his brother's cage and the key at the top of the screen.

There are four screens each with a different type of chaser, starting with gnashing teeth, then Aardvark birds and electric spikes. These move up and down the screen and can be killed by dropping apples and pineapples on them.

The movement is interesting. You can move from rope to rope horizontally as well as vertically.

The major failing is the annoying music that plays throughout, thank goodness a silent option is available. The sound is interesting in another way for there are no sound effects whatsoever, just music.

One final niggle is that the score is only updated if the screen is ended and not for each success that you have. The graphics are in four colours and this makes the game more cartoon like. It stands out from the crowd.

D.C.

instructions	80%
playability	90%
graphics	95%
value for money	90%



Loderunner 48K Spectrum £9.95

Software Projects, Bearbrand
Complex, Liverpool L25 7SF

A version of the familiar ladders, platforms and digging game. Having said that, it features the tiniest animated graphics I've ever seen. The most complex set of facilities allows you to create your own screens, jump to new levels, and gain extra lives. There are 150 different screens, and a 20 page software protection code sheet.

The graphics work beautifully. Your man climbs, jumps, floating elegantly to earth, and crawls along monkey bars, to avoid chasers. In addition, he drills through floors, creating pits into which his adversaries fall. It's all too easy to drop into them yourself though!

The ladders and platforms are delicately drawn, reminding me of lace, but the variations available are mind boggling! The small size means that great complexities can be structured on one screen. If you fancy redesigning it, you can, and even save your creation to tape for reloading later.

You collect gold bars underground to amass a fortune. There must be months of enjoyment here. Just one gripe! The excellent editing facilities are barely mentioned in the insert, so you'll have to struggle till you get the hang of it!

D.M.

instructions	65%
playability	100%
graphics	90%
value for money	90%



HCW regular contributor Shingo Sugiura has written a BBC disassembler which will come in really handy

BBC micro owners are fortunate to be gifted with a built-in assembler which is not only very powerful but also easy to use. However, for some unknown reason, Acorn did not include a disassembler. To rectify this omission here is a simple but effective disassembler written in BASIC for the BBC micro. It will be very useful if you want to delve into the operating system or learn how some machine code programs do the clever things they do!

Even if you are still learning machine code, you're advised to type in this program because anyone at all serious about programming will at some stage get interested in machine code and need a disassembler.

When this program is run, you are asked to input the start address. This is the address from which you want the disassembly to start. After inputting the end address, the disassembly begins. As an example, run the program and

enter 8000 and 8050 as the start and end addresses respectively (notice that although the addresses are in hexadecimal, they are not preceded by "&").

The disassembly of the first few bytes of the BASIC ROM should appear. The left column is the address, the next column is the opcode (or data as the case may be) in hex, the next column is the actual mnemonic and the last column is its ASCII equivalent (any non-ASCII characters are represented by a full stop). During disassembly, any invalid opcodes are assumed to be a single byte instruction and replaced by "???". The disassembly will be in paged mode so after a screenfull, the listing will stop until you press "SHIFT". Disassembly may be stopped at any time simply by pressing the ESCAPE key.

How it works

The program consists mainly of a big look-up table of mnemonics. The mnemonics are stored in the array "mnemonic\$" and the addressing mode for each instruction is stored in "mode".

Addressing mode

a implied
b immediate
c absolute
d indexed
e indexed
f relative
g zero page
h zero page,X
i zero page,Y
j accumulator
k indirect
l pre-indexed indirect
m post-indexed indirect

There are 13 addressing modes and in the DATA table at the end of the program they are represented by lower case letters.

Here is a run down of the different addressing modes and an example of each.

Example

```
RTS
LDA #&FF
LDA &1900
LDA &7C00,X
LDA &7C00,Y
BEQ loop
LDA &70
LDA &70,X
LDA &70,Y
LSR A
JMP (&020A)
LDA (&0C00,X)
LDA (&70),Y
```

Given the start address, the program PEEKs at that address and looks up the mnemonic and the addressing mode corresponding to that number. This allows the program to work out how many of the following bytes belong to the instruction and consequently, where the next instruction starts. This process is repeated until the end address is reached. For those of you who like to understand the nitty-gritty

of a program, here's a detailed run-down:

```
10-30 REM statements
50 trap error
60 select MODE7, switch off flashing cursor
70 call procedure which assembles sort machine code routine (explained later)
80-90 input start address
100-110 input end address.
Both start and end addresses are expected to be in hex
```

BBC disassembler

without the preceding "&". The function EVAL is used to convert the string into a number

```
120 set up screen
130-190 main loop
200 end of main loop
210 beginning of procedure decoding the opcodes passed through as a parameter
220-230 print mnemonic and addressing mode
240 force a newline
250 end of this procedure
260-630 various procedures which prints the addressing mode appropriately
640-720 print the opcodes in hex and ASCII
730-760 a procedure which prints a 16-bit number in hex with leading zeroes
770-830 this procedure is called at the beginning of disassembly. The start and end address is printed at screen top and then a text window is defined so that the addresses do not get scrolled off the screen
840-980 assemble a short machine code routine which prints an 8-bit number held in the accumulator in hex. The basic equivalent " " was not used because the latter omits the leading zeroes
990-1070 store the mnemonics and the addressing modes in readable form
1080-1400 mnemonics and their addressing modes
```

Since the program was written to be just a simple disassembler, there is a lot of room for improvement. A very simple improvement would be the addition of a print-out option. I didn't include this option because I didn't know what proportion of BBC users own printers. Another obvious improvement would be the labelling of operating system calls. So JSR &FFEE would become JSR oswrch. This improvement will lengthen the program only slightly and will greatly improve the legibility of the disassembled code.

Ultimately, a disassembler should be written in machine code and burnt into ROM but for most of us, even a simple disassembler such as this one will be very useful.

Hints on conversion

Obviously, it is no use converting this program if your micro doesn't have a 6502 CPU although the structure of the program may be retained. However, if you do have a 6502 based micro (such as the Oric, Atari, CBM 64, VIC etc) you can virtually translate the program line by line. Many of the "structured" commands such as REPEAT-UNTIL, PROC, FN on the Beeb are not available on other micros thus have to be replaced.



```

10 REM Disassembler
20 REM By Shingo Sugiura
30 REM July 1984
40
50 ON ERROR VDU15,10,13:END
60 MODE7:VDU23;8202;0;0;0;
70 PROCassemble
80 INPUT"Start address>"code$
90 address%=EVAL("&"+code$)
100 INPUT"End address >"code$
110 end%=EVAL("&"+code$)
120 PROCset_up
130 REPEAT
140   PROChex(address%)
150   opcode%=?address%:type%=mode?opcode%
160   PROCdecode(opcode%,type%)
170   address%=address%+byte%
180   UNTILaddress%>=end%
190 VDU15
200 END
210 DEFPROCdecode(code%,type%)
220 PRINTTAB(16,VPOS)mnemonic$(code%) " "mode$(type%);
230 PROCmode(type%)
240 PRINT
250 ENDPROC
260 DEFPROCmode(type%)
270 IF type%=0 byte%=1 ELSE IF type%=1 PROCimmediate
280 IF type%=2 OR type%=3 OR type%=4 PROCabs ELSE IF type%=5 PROCrelative
290 IF type%=6 OR type%=7 OR type%=8 PROCzero ELSE IF type%=9 byte%=2
300 IF type%=10 PROCind ELSE IF type%=11 OR type%=12 PROCindX
310 PROCmemory(byte%)
320 ENDPROC
330 DEFPROCimmediate
340 byte%=2
350 A%=address%?1:CALLcode
360 ENDPROC
370 DEFPROCabs
380 byte%=3
390 PROChex(address%!1 AND &FFFF)
400 IF type%=3 PRINT",X"; ELSE IF type%=4 PRINT",Y";
410 ENDPROC
420 DEFPROCrelative
430 byte%=2
440 offset%=address%?1+1
450 IF offset%>127 offset%=offset%-256
460 branch%=address%+offset%+1
470 PROChex(branch%)
480 ENDPROC
490 DEFPROCzero
500 byte%=2
510 A%=address%?1:CALLcode
520 IF type%=7 PRINT",X"; ELSE IF type%=8 PRINT",Y";
530 ENDPROC
540 DEFPROCind
550 byte%=3
560 PROChex(address%!1 AND &FFFF)

```

```

570 PRINT")"
580 ENDPROC
590 DEFPROCindX
600 byte%=2
610 A%=address%?1:CALLcode
620 IF type%=11 PRINT",X)"; ELSE PRINT",Y)";
630 ENDPROC
640 DEFPROCmemory(count%)
650 FOR loop%=0 TO count%-1
660   PRINTTAB(6+loop%*3,VPOS);
670   peek%=address%?loop%
680   A%=peek%:CALLcode
690   PRINTTAB(28+loop%,VPOS);
700   IF peek%>31 AND peek%<127 PRINTCHR$(peek%); ELSE PRINT". ";
710   NEXT
720 ENDPROC
730 DEFPROCchex(number%)
740 A%=number% DIV 256:CALLcode
750 A%=number% MOD 256:CALLcode
760 ENDPROC
770 DEFPROCset_up
780 CLS
790 PROCchex(address%)
800 PRINT">";
810 PROCchex(end%)
820 VDU28,0,24,39,1,30,14
830 ENDPROC
840 DEFPROCassemble
850 DIM code 100,mode 256,mode$(13),mnemonic$(256)
860 oswrch=&FFEE
870 FOR pass=0 TO 2 STEP2:P%=code
880   [OPT pass
890   .phex
900   PHA:AND#&F0
910   ROR A:ROR A:ROR A:ROR A
920   JSR hex
930   PLA:AND#&0F:JMP hex
940   .hex
950   ORA#&30:CMP#&3A:BMI out
960   ADC#6
970   .out JMP oswrch
980   INEXT
990 FOR loop%=0 TO 255
1000   READ data$
1010   mnemonic$(loop%)=RIGHT$(data$,3)
1020   mode?loop%=ASC(LEFT$(data$,1))-ASC"a"
1030   NEXT
1040 FOR loop%=0 TO 12
1050   READ mode$(loop%)
1060   NEXT
1070 ENDPROC
1080 DATA aBRK,gORA,a???,a???,a???,gORA,gASL,a???,
1090 DATA aPHP,bORA,jASL,a???,a???,cORA,cASL,a???,
1100 DATA fBPL,mORA,a???,a???,a???,hORA,hASL,a???,
1110 DATA aCLC,eORA,a???,a???,a???,dORA,dASL,a???,
1120 DATA cJSR,lAND,a???,a???,gBIT,gAND,gROL,a???,
1130 DATA aPLP,bAND,jROL,a???,cBIT,cAND,cROL,a???,
1140 DATA fBMI,mAND,a???,a???,a???,hAND,hROL,a???,

```

Ventures

Peter Sweasey takes you down into the depths of the Underwulde this week — read on

It's time to step down once more into those dark dungeons, as HCW's regular column takes you through the world of adventures and arcade adventures (arcventures). This time I'll be looking at the two new Ultimate games; the second prize winner in the Cambridge Awards from CCS and some of the Games Without Frontiers series. My elfling secretary, Gorand, is still dealing with your letters, so the helpline is quite short this week, but we do have some help with Valkyrie 17, Pyjamarama and The Hobbit.

Ultimate was probably the company responsible for first bringing the arcventure to our keyboards. Atic Atac was a simple, early but highly popular game, and after a brief lapse back into strict arcade with Sabre Wulf, it's nice to have Ultimate back on the arcventure field. Underwulde and Knight Lore are very different in some ways, but do have some common factors, most obviously Sabre Man.

First to arrive in the shops was Underwulde, which, of the two, has more arcade bias. You are trapped in a castle, hidden beneath which is the underwulde. Your task is to find the ultimate place of darkness where your path to escape lies. Out to stop you are various rather nasty, creatures who like to get in your way but do not kill you.

You do not walk very much in this castle — you leap from the furniture or jump between the rocks in the underwulde caverns, and meeting a creature will cause you to ricochet off in another direction. Falling through more than one screen will lose you a life. You must collect your weapons as well, which need to pass the guardians of deeper caves, and there are also some handy blue gems which make you invincible. Add to all this ropes, falling stalagmites, and volcano bubbles for travelling upwards and you have a very complex game.....

Underwulde stretches over many screens of perfect graphics. Animation is superb and colour well used. The game really has an adventure feel to it and is begging to be mapped — maybe some HCW readers would like to have a go? It will certainly take a long time to master.

The same can be said for Knight Lore which will probably revolutionise the software market. This time you have travelled from the jungle to a different castle to seek the advice of a wise wizard. Your problem

is, you keep turning into a werewolf when the moon comes out. The wizard advises you to locate a potion — but doing this means passing through more than 100 rooms full of traps, discovering problems to solve, objects to use and evil things to defeat.

It's a difficult, game to describe because it is so different. For a start, it uses Filmation, a process whereby you can do what you want with the things you come across. The graphics have to be seen to be believed; they are in full 3-D perspective and move so smoothly they resemble a laserdisc.

Words fail me when trying to describe it: sound is delightful, colour is good and animation incredible. Like Underwulde, it is wonderfully addictive and has all the features you would expect from Ultimate, i.e. joystick options, hyperload and the best presentation ever. At £9.95 Underwulde is a good buy, but Knight Lore almost ridiculously cheap. Buy them!

After such excited rantings, back down to earth with 1942 Mission, £5.95 from CCS. This was the second prize winner in the Cambridge Awards — I would hate to see what came third. You are an agent in, strangely enough, 1942, who must parachute into a German camp and steal some secret plans. "In this complex adventure", says the inlay, "there are 77 verbs and over 38 objects (39 I guess) to help you".

It serves as a good example of how far adventures have progressed recently, since only the instructions are any good. It's written in BASIC with some very dull descriptions and a century-long response time. It represents a boring idea and with the availability of the Quill it should not be on the market. Very poor for the price and I hope the winner, The Prince, was a lot better. I hope to look at this in the future.

A razor-sharp contrast is the Games without Frontiers series from 8th Day which retail at £1.75. All six adventures are written with the Quill, have excellent instructions and are on the whole well worth it. I looked at three of them a month or so ago in the main magazine, and since then have received Four Minutes to Midnight, Cuddles and Quann Tulla, which are of similar quality.

Four Minutes is a sort of nuclear holocaust game where

you have to collect five people and take them across America to a safe city. I say "sort of" because the instructions insist an epidemic has caused the mass destruction. Still, the game is very sophisticated of its type, since it has a few graphics and some clever features.

Cuddles is not so complex; you play the part of a baby who wants to escape from its playpen and explore the outside world. The problems are quite interesting, but the game leads you into doing what the author wants, rather than exploring.

Quann Tulla is set on a space station, and whilst not particularly original, it has nice descriptions and is fun to play. So overall, the Games Without Frontiers set is well worth looking at, and I look forward to seeing more from 8th Day.

There is a real rush on to release 'ventures for Christmas now — and hopefully, I shall cover those to put on your list to Santa Claus as well as those to tell him to leave in the north pole with the polar bears, over the next few weeks.....

Now for the help. Firstly, I was very pleased to see Valkyrie 17 burst into the charts recently. It is a very good adventure, and for those struggling, here is some help. To leave the hotel, it is necessary to go out the window and enter another room — then

to get to the ground think of a jail break! And to tumble the safe, a bit of vandalism might be just what the doctor ordered..... Does anyone know how to ski however, and where is that elusive currency?

Pyjamarama from Mikro-Gen is an excellent arcventure and people are beginning to complete it now. Christopher Lovelace from Fullbrook and William Duff from Scotland both wrote in with full solutions — no more please. Well, I am not going to tell you exactly how to do it, but a few gentle pushes in the right direction should be enough. Firstly, you need to swop a pound then spend a penny to access that fire extinguisher. Water keeps the plants at bay and fuel powers any good rocket. Laser guns might kill those aliens — but are you power-full? Crash helmets help driving and you need the magnet from the kitchen more hints next time.

Piers Hogarth-Scott of Bristol, writes about The Hobbit. To leave the goblin's dungeon, tell someone to give you a lift — literally — out that window to the West.

That's it for this time, I shall crawl back into my dungeons now and read those letters, carefully sorted by Gorand. Keep writing them please!



The Music System BBC B £24.95

Island Logic, 22 St Peter's Sq, London W6 9NW

A well packaged comprehensive system is offered contained in a video style vinyl box. There are two discs, one containing the system operators and the other a 'song and sound library'. You also get a manual which, over 75 pages, explains in considerable detail the operation of the system and finally some cut out strips to help with the keyboard commands.

The quality of the product is evident throughout. I found that everything worked as it should, smoothly and with a minimum of fuss after a short period of familiarisation. Full marks for user friendliness. This was also largely due to the use of icons and other appropriately placed graphics.

The "Quick Guide To The Music System" was idiot proof (I should know!) and allowed you to sample all the main features very rapidly. The writer adopts a lighthearted approach with occasional flashes of wit (like the explanation of icons — "we don't mean Russian religious artifacts, but easy-to-remember symbols").

On powering up you enter the Control Screen which gives you access to all the facilities. There are five main areas each with their own routes and jobs.

The first of these is the Editor. This, if you are composing is your equivalent of an assembler. The range is impressive allowing four octaves on the music staves and placed in any key with the facility to transpose into any other key. Your input can be edited and displayed in classic notation. Tempos range from 30 to 200 crotchet beats per minute. All notes are entered directly on the staves with one keypress.

The Synthesiser allows fifteen sound shapes to be saved as 'music envelopes'. The sound is made up by defining 19 parameters and the creation can be heard immediately. A frequency and amplitude graph

is an additional features which can also be used to update the envelope parameters. Extensive use of icons make this section easier than it seems.

The Keyboard gives you an alternative method of composition. With graphic displays you can try out a tune with the sounds created by the Synthesiser. Notes appear on screen as you depress a key in position on the screen keyboard. This was a marvellous opportunity to test all sorts of tunes with the ability to store pieces on a multi-track on screen recorder.

The Linker is, as the name suggests, a section allowing up to ten files to be joined, and played back as one piece. Other facilities make this a versatile option.

The final section is the Printout which I wasn't able to try out. The manual says it's compatible with Epson RX, FX and Star Delta series dot matrix printers.

There are many additional features which allow a great flexibility in composing and playing with sounds. The utilities allow easy storage and transfer from one section to another. Three further programs allow you to copy the Song and Sound Library from 40 track disk to 80 track disk. You can copy music files from disk to cassette and vice versa and can extract envelope files from music files.

There is all this plus the ability to listen to some pre-recorded examples to inspire you to greater things. It was an easy program to use, versatile in its application allowing a child to experiment and a composer to give free range to his imagination. At this price it is highly

In-depth analysis

This week we bring you the first of many in-depth reviews on the more expensive utilities available for all types of computer. Read an expert opinion before you buy

commended.	M.P.
instructions	95%
display	100%
ease of use	95%
value for money	100%



Breden's BASIC CBM-64 £39.95

Visions, 1 Felgate Mews, Studland St, London W6 9JT.

Visions have come up with yet another extended BASIC package for the CBM-64. For your money you receive a 160 page manual and the extended BASIC on both tape and disk. The idea of supplying both cassette and disc is a good way of catering for all types of system and expansion.

The language covers almost all areas of programming. Unfortunately there are not many extra aids to machine code programmers. This may not be so important to an expert but for a beginner in this field it would be most helpful.

The sprite graphics commands are very good. You only need to supply the computer with sprite shapes — all the POKES and setting up of memory areas is done for you. The limitation is that you may only have 16 sprite definitions to use in eight sprites, although you may change these at any time. A sprite may be moved from one point to another on the screen by specifying its destination. The computer will then scroll it smoothly between the points. Collision detection is also handled very well.

The graphics commands go no further than drawing lines and boxes. The features such as circles, arcs, painting and drawing pre-defined shapes found in Simon's BASIC are not present in Breden's BASIC.

Full control over sound is given, it is even possible to play chords quite easily. The nice thing about the sound commands is that they take away all of the

cumbersome POKES that are normally required and so make listings more legible.

The extra I/O commands for reading the keyboard, joysticks and paddles seem to be quite a waste of time. They all have well known single PEEK/POKE equivalents. Using the Breden's BASIC commands here ohly makes your programs incompatible with a standard 64.

Programmers aids supply find, delete, memory load & save, old and function key commands along with some others which are not needed.

The enhanced programming structures provide good commands which make general programming easier and more structured.

In conclusion I will say that Breden's BASIC has some good features but these are cancelled out by about half of the commands being unnecessary and serving no real purpose. Surely an extended BASIC should allow the programmer to do new things, not already existing ones in a different way.

K.I.

instructions	95%
ease of use	80%
value for money	65%



Breden's BASIC



Island Logic

Find where you buried the bone — watching out for marauding birds — and stack them in your dog bowl. A true family game from R N Butcher

This arcade-type game is suitable for a younger child, but the graphics should be good enough for use in a family group.

The idea is to throw three bones into the dog bowl, firstly finding where they are buried, and then hoping a bird doesn't fly down and intercept them.

Extra time faults are added to your time for failure to get three bones, and every time you dig and fail to find a bone.

Whether a bone is found in a particular position or not is determined before the start of each game and not immediately after each key press.

Instructions are included in the program.

How it works

1-19 moves bone and bird
 20 checks if collision
 21-30 moves bone (through)
 34-38 moves bone (collision)
 39-44 returns bird
 45 checks for end of game
 105-107 before game gives each horizontal position a value
 110 sets variables
 112-113 checks for keys press
 114 determines where bone found or not
 116-117 move dog, check for end game
 122 checks for any +60
 124-125 checks for best time
 127-128 best time (visual and sound effects)
 129-138 asks and prepares screen for new game
 140-170 end screen
 201-205 "bubble" speech
 300-305 starts timer
 306-308 PEEKs timer and prints score
 400-411 selects and plays success tune
 421-427 failure tune
 500-525 title screen
 526-530 instruction/game prompt
 600 instructions
 602-605 prints multicoloured instructions
 700-9710 POKE UDGs and set up screen

Give a dog a bone

Variables

a\$,b\$,c\$,d\$ dog graphics
 x\$,y\$,z\$ bush graphics
 k\$ instructions
 hi best time
 game if game = 1 then best time routine
 a vertical position of dog
 b horizontal position of dog
 l,g horizontal position of bone
 r,j vertical position of bone
 i,o vertical position of bird
 bones number of bones in bowl
 sc time in 1/2 seconds and ex
 ex 10 added to sc for no bone
 q,x BEEP values
 br BORDER colour for flash
 pa PAPER colour for title screen
 ti Spectrum clock
 w first horizontal position of bone
 n WK colour for instructions
 u random choice of tune
 v(r), v(b) holes no (1-100) for each horizontal position of bone or not

Screen dump

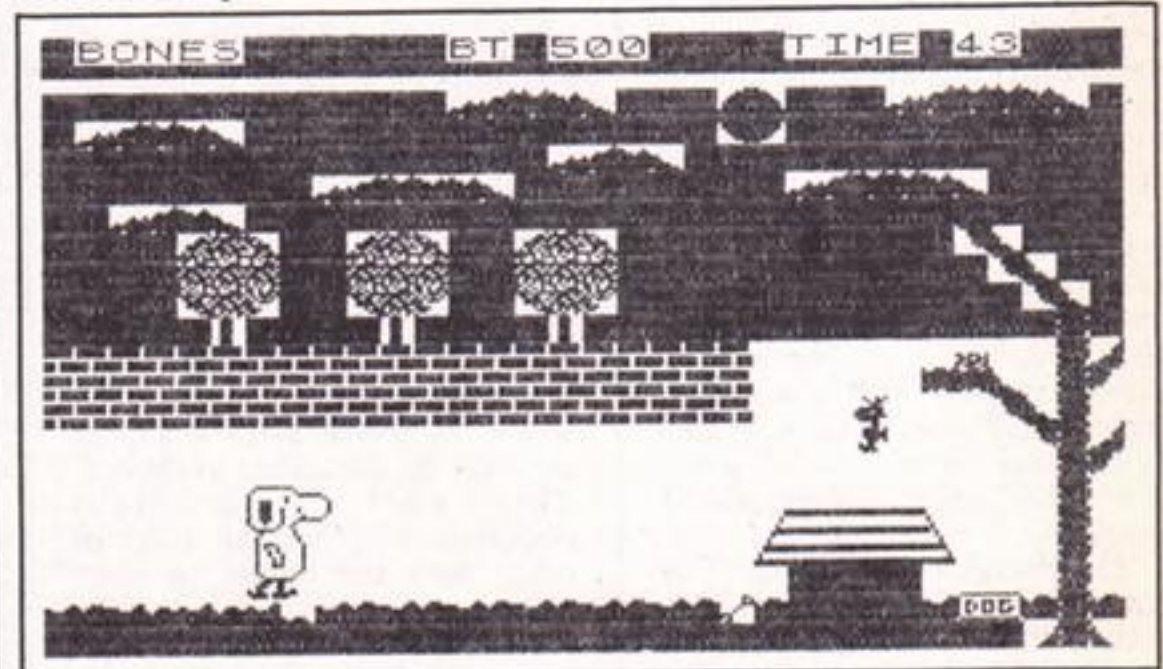

```
1 BORDER 0: BRIGHT 1: CLS : PAPER 7: RANDOMIZE 0: LE
T hi=500: LET game=0: GO SUB 500: GO SUB 7000:
2 GO SUB 300: GO SUB 100
3 FOR w=1 TO (16-b)
4 PRINT AT 15,w+b+3; " "
5 PAUSE 5
6 PRINT AT 15,w+b+3; " "
7 NEXT w
8 PRINT AT 15,w+b+3; " "
9 FOR o=11 TO INT (RND*5)+10
```

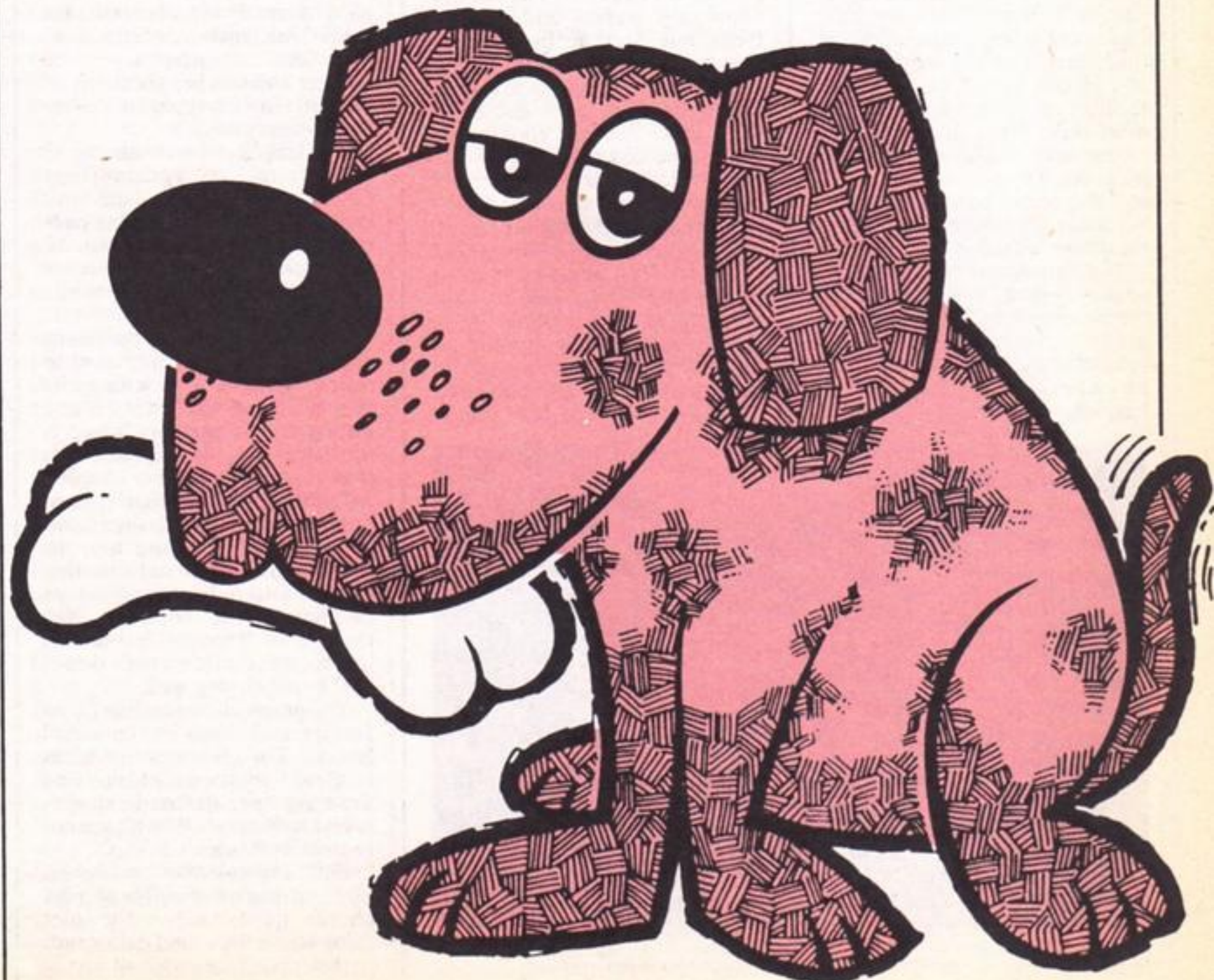

PROGRAM

```
10 PRINT AT o,24;" ";AT o+1,24;" "
11 PAUSE 5
12 PRINT AT o,24;" ";AT o+1,24;" "
13 NEXT o
14 PRINT AT o,24;" ";AT o+1,24;" "
15 FOR g=20 TO 23
16 PRINT AT 15,g;" "
17 PAUSE 5
18 PRINT AT 15,g;" "
19 NEXT g
20 IF o=15 OR o+1=15 THEN GO TO 33
21 FOR g=24 TO 26
22 PRINT AT 15,g;" "
23 PAUSE 5
24 PRINT AT 15,g;" "
25 NEXT g
26 FOR j=16 TO 19
27 PRINT AT j,20;" "
28 PAUSE 5
29 PRINT AT j,20;" "
30 NEXT j
31 GO SUB 400
32 LET bones=bones+1: PRINT PAPER 6;AT 0,6+bones;"
: GO TO 39
34 FOR t=23 TO 21 STEP -1: PRINT AT 15,t;" ": PAUSE
5: PRINT AT 15,t;" ": NEXT t
35 FOR r=16 TO 20: PRINT AT r,20;" "
36 PAUSE 5
37 PRINT AT r,20;" "
38 NEXT r: PRINT AT 20,20;" ": GO SUB 420
39 FOR i=o TO 12 STEP -1
40 PRINT AT i,24;" ";AT i+1,24;" "
41 PAUSE 5
42 PRINT AT i+1,24;" "
43 NEXT i
44 PRINT AT i,24;" ";AT i+1,24;" "
45 IF bones=3 THEN GO TO 121
46 GO TO 116
105 DIM v(16): FOR r=1 TO 16
106 LET y=INT (RND*100)+1: LET v(r)=y: PAUSE 5
107 NEXT r
110 LET sc=0: LET a=16: LET b=1: LET bones=0: LET q=.1
5: LET x=.3: PRINT AT 0,15;hi;AT 0,27;sc
111 GO SUB 117
112 PAUSE 0: IF INKEY$="p" THEN GO SUB 116
113 IF INKEY$<>"q" THEN GO TO 112
114 IF v(b)>=51 THEN PRINT AT 20,b+1;" ": PAUSE 50:
PRINT INK 4;AT 20,b+1;" ": PRINT AT a,b-1;" ": PAUSE
50: PRINT AT a,b-1;" ": GO TO 3
115 PRINT AT 20,b+1;" ": LET ex=ex+10: GO SUB 306
116 PRINT AT a,b;" ";AT a+1,b;" ";AT a+2,b;" ";AT a+3,
b;" ": LET b=b+1: IF b>16 THEN GO TO 120
117 PRINT AT a,b;a$;AT a+1,b;b$;AT a+2,b;c$;AT a+3,b;d
$
118 GO TO 112
120 PRINT AT a,b-1;a$;AT a+1,b-1;b$;AT a+2,b-1;c$;AT a
+3,b-1;d$: GO SUB 306: GO TO 122
121 GO SUB 306
122 LET game=game+1: IF bones<3 THEN LET sc=sc+(3-bon
es)*60
123 GO SUB 200
124 IF sc<hi THEN LET hi=sc
125 IF sc>hi THEN GO TO 129
126 IF game=1 THEN GO TO 129
127 FOR y=1 TO 100: LET br=INT (RND*7)+1: BORDER br: B
EEP .01,y/2: NEXT y
128 FOR f=1 TO 3: BEEP q,2: BEEP q,4: BEEP q,6: BEEP x
,7: BEEP q,2: PAUSE 7: BEEP q,7: BEEP q,6: BEEP q,7: BE
EP x,9: BEEP x,4: PAUSE 10: NEXT f
129 PRINT INK 3;AT 0,15;" ": PRINT AT 0,27;sc;
AT 0,15;hi
130 PAUSE 100: PRINT PAPER 6;AT 21,0;"**** Another g
ame ? (y/n) ****"
131 PAUSE 0:
132 IF INKEY$<>"y" AND INKEY$<>"n" THEN GO TO 131
133 IF INKEY$="n" THEN GO TO 140
134 IF INKEY$="y" THEN PRINT INK 4;AT 21,0;"
"
135 PRINT INK 6;AT 0,7;" ": PRINT INK 4;AT 0,27
;" "
136 PRINT AT a,b-1;" ";AT a+1,b-1;" ";AT a+2,b-1
;" ";AT a+3,b-1;" "
137 BORDER 0: FOR f=0 TO 20 STEP 2: PRINT INK 4;AT 20
,f;" ": NEXT f
138 FOR e=14 TO 16: PRINT AT e,b+2;" ": NEXT e
139 GO TO 2
140 PAPER 5: CLS : PAPER 5: PRINT AT 5,5;"TODAYS BEST
TIME ";hi
141 FOR f=40 TO 120
144 LET a=INT (RND*4)
145 PLOT f,a+50
146 NEXT f
150 PRINT AT 11,8;a$;AT 12,8;b$;AT 13,8;c$;AT 14,8;d$
```

```
160 PLOT 87,80: DRAW 20,5: DRAW -16,0: DRAW 0,13,-PI:
DRAW 64,0: DRAW 0,-13,-PI: DRAW -30,0: DRAW -38,-5
170 PRINT AT 10,12;"GOODBYE": PAUSE 0
200 PLOT (b+3)*8,40: DRAW 8,5: DRAW -10,0: DRAW 0,12,-
PI: DRAW 34,0: DRAW 0,-12,-PI: DRAW -14,0: DRAW -16,-5
201 IF sc<hi THEN PRINT AT 15,b+3;"best": RETURN
202 IF sc<100 THEN PRINT AT 15,b+3;"good": RETURN
203 IF sc<150 THEN PRINT AT 15,b+3;"fair": RETURN
204 IF sc<175 THEN PRINT AT 15,b+3;"O.K": RETURN
205 IF sc>=176 THEN PRINT AT 15,b+3;"poor": RETURN
300 PRINT FLASH 1;AT 16,3;"START";AT 15,3;"*****";AT
17,3;"*****": PAUSE 0: PRINT AT 16,3;" ";AT 15,3;"
";AT 17,3;" "
301 LET ex=0
302 LET p=23672
303 POKE p+2,0
304 POKE p+1,0
305 POKE p,0
306 LET ti=PEEK (p)+256*PEEK (p+1)+65536*PEEK (p+2)
307 LET sc=INT (ti/25)+ex
308 PRINT AT 0,27;sc
309 RETURN
400 LET u=INT (RND*2)+1: IF u=1 THEN GO TO 410
403 BEEP x,0: BEEP x,0: BEEP q,4: BEEP .4,7: PAUSE 3:
BEEP q,7: BEEP q,7: BEEP q,4: BEEP q,4: BEEP q,2: BEEP
q,0: BEEP .5,2
404 GO SUB 306
405 RETURN
411: BEEP q,7: BEEP q,7: BEEP q,7: BEEP q,4: BEEP q,7:
BEEP q,9: BEEP q,7: BEEP .5,4: BEEP q,4: BEEP .75,2: B
EEP q,4: BEEP .5,2
412 GO SUB 306
413 RETURN
421 BEEP .01,8: BEEP x,9: BEEP q,12: BEEP .01,8: BEEP
q,9
422 PAUSE 10
423 BEEP .01,8: BEEP x,9: BEEP q,12: BEEP .01,8: BEEP
q,9
424 PAUSE 10
425 BEEP q,10: BEEP q,12: BEEP q,10: BEEP x,7
426 PAUSE 10
427 BEEP q,9: BEEP q,12: BEEP q,9: BEEP x,5
428 GO SUB 306
429 RETURN
500 LET pa=INT (RND*3)+4: PAPER pa: CLS : PAPER pa
510 PLOT 16,160: DRAW 0,-64
511 PLOT 48,160: DRAW -32,-32: DRAW 32,-32
512 PLOT 8,168: DRAW 48,0: DRAW 0,-80: DRAW -48,0: DRA
W 0,80
513 PRINT AT 9,7;"ENNEL"
514 PLOT 72,80: DRAW 0,-64
515 PLOT 104,80: DRAW -32,-32: DRAW 32,-32
516 PLOT 64,88: DRAW 48,0: DRAW 0,-80: DRAW -48,0: DRA
W 0,80
517 PRINT AT 19,14;"APERS"
518 PLOT 112,136: DRAW 16,16: DRAW 40,0: DRAW 16,16: D
RAW 48,0: DRAW 16,-16: DRAW 0,-72: DRAW -8,-8: DRAW -32
,0: DRAW -16,24
519 DRAW -64,0: DRAW -16,16: DRAW 0,24
520 FOR f=1 TO 5: CIRCLE 107,124,f: NEXT f
521 CIRCLE 195,144,5
522 CIRCLE 194,144,1
523 PLOT 244,14: DRAW -82,0,PI/1.3: DRAW 82,0: PRINT A
T 17,24;"by";AT 19,21;"R.Butcher"
524 PLOT 164,96: DRAW 20,8: DRAW 4,10
525 FOR f=5 TO 9: PRINT AT f,27;" ": NEXT f: PRIN
T AT 10,27;" ";AT 11,28;" "
526 PRINT #1;"(i) instructions (g) game"
527 PAUSE 0
528 IF INKEY$<>"i" AND INKEY$<>"g" THEN GO TO 527
529 IF INKEY$="i" THEN GO TO 600
530 CLS : PAPER 7: CLS : RETURN
600 CLS : PAPER 7: CLS : PRINT INVERSE 1;AT 1,9;"KENN
EL KAPERS"
601 LET k$="Help Lassie,the Labrador,to fillher dog bo
wl with 3 bones in theshortest time.But first you havet
o find where they are buried using the keys Q to dig
or P to go forward.Every time you dig and no bone is
found 10 is addedto the time.Hovering above the kennel
is a bird which tries to stop the bones.If the kennel
isreached without the 3 bones,60 is added for every b
one short.To**START** the game press any key"
602 FOR l=1 TO LEN k$
603 LET n=INT (RND*5)+1: PAUSE 3
604 PRINT INK n;k$(l);
605 NEXT l
606 PRINT ; FLASH 1;AT 20,8;"Press any key": PAUSE 0
607 CLS : RETURN
7000 RESTORE 7000: FOR a=USR "a" TO USR "u"+7
7010 READ b: POKE a,b
7020 NEXT a
7030 DATA 254,254,254,0,239,239,239,0: REM wall
7040 DATA 0,0,0,4,15,127,255,239: REM cloud a
7050 DATA 1,3,31,191,255,255,255,223: REM cloud b
```

SPECTRUM PROGRAM

```

7060 DATA 33,243,255,255,255,255,247: REM cloud c
7070 DATA 0,194,247,255,255,255,255: REM cloud d
7080 DATA 0,0,0,192,224,248,254,127: REM cloud e
7090 DATA 0,3,199,255,255,255,255: REM grass a
8000 DATA 0,28,191,255,255,255,255: REM grass b
8001 DATA 1,1,2,2,4,7,15,8: REM roof a
8002 DATA 16,16,63,63,64,64,255,255: REM roof b
8003 DATA 128,128,64,64,32,224,208,16: REM roof c
8004 DATA 8,8,252,252,2,2,255,255: REM roof d
8005 DATA 255,255,0,0,0,255,255,0: REM roof e
8006: DATA 0,0,255,255,0,0,255,255: REM roof f
8007 DATA 255,0,255,0,255,0,255,0: REM kennel s
8011 DATA 0,0,1,1,3,7,15,31: REM trunk l
8012 DATA 0,0,128,128,192,224,240,248: REM trunk r
8013 DATA 255,255,254,127,255,255,126,254: REM trunk
8014 DATA 157,255,255,255,255,255,211,0: REM branch
8015 DATA 127,31,31,15,15,7,1,0: REM slope bl
8016 DATA 128,128,192,224,224,248,252,255
8017 FOR f=1 TO 10: FOR g=0 TO 31: PRINT ; INK 5;AT f,g
; " : NEXT g: NEXT f
8018 PAPER 5: PRINT INK 7;AT 2,12;" " : AT 6,2;
" : AT 2,25;" " : AT 4,15;" "
8019 PRINT INK 7;AT 5,22;" " : AT 3,1;"
" : AT 5,8;" "
8020 FOR a=0 TO 31: PRINT INK 4;AT 21,a;" " : NEXT a
8021 PAPER 7: FOR a=0 TO 31 STEP 2: PRINT INK 4;AT 20,
a;" " : NEXT a
8022 PAPER 6: FOR f=11 TO 13: FOR g=0 TO 20: PRINT INK
2;AT f,g;" " : NEXT g: NEXT f
8023 PAPER 4: PRINT INK 3;AT 21,29;" " : FOR f=10
TO 21: PRINT INK 3;AT f,30;" " : NEXT f
8024 PAPER 5: PRINT INK 3;AT 7,27;" " : AT 8,28;"
";AT 9,29;" " : PAPER 7: PRINT INK 3;AT 12,26;"
";AT 13,28;" " : AT 14,29;" "8025 PRINT INK 0;AT 17
,21;" " : AT 18,21;" " : AT 19,22;"
" : AT 20,22;" "
8026 PRINT INK 6;AT 0,0;" " : INK
3;AT 0,11;" " : INK 4;AT 0,21;" "
"
8027 PRINT AT 0,1;"BONES";AT 0,12;"BT";AT 0,22;"TIME"
8029 PRINT PAPER 5;AT 1,0;"
"
9020 RESTORE 9020: FOR a=USR "a" TO USR "o"+7
9021 READ b: POKE a,b
9022 NEXT a
9023 DATA 254,248,248,240,240,224,128,0: REM slope br
9024 DATA 1,1,3,7,7,31,63,255: REM slope tr
9052 DATA 56,56,56,56,56,56,56,56: REM tree
9053 DATA 78,255,186,109,247,190,171,210
9054 DATA 128,224,208,124,188,54,239,85: REM bush
9055 DATA 1,6,15,61,59,85,250,235: REM bush
9056 DATA 215,93,170,220,192,240,96,128
9057 DATA 170,247,108,61,62,11,7,1
9058 DATA 127,128,179,170,170,179,128,127: REM bowl l
9059 DATA 254,1,185,161,173,185,1,254: REM bowl r
9060 DATA 0,0,0,0,221,119,221,187: REM nest
9061 DATA 3,15,31,63,127,127,255,255
9062 DATA 192,240,248,252,254,254,255,255
9063 DATA 255,255,127,127,63,31,15,3
9064 DATA 255,255,254,254,252,248,240,192
9130 PAPER 5: PRINT INK 6;AT 2,20;" " : AT 3,20;"
"
9150 PAPER 7: PRINT INK 3;AT 11,31;" " : AT 12,31;" "
9151 PRINT INK 3;AT 14,31;" " : AT 15,31;" "
9158 PAPER 5: FOR f=5 TO 15 STEP 5: PRINT INK 0;AT 10,
f;" " : NEXT f
9159 LET x$=" " : LET y$=" " : LET z$=" "
9160 PAPER 5: FOR b=4 TO 14 STEP 5: PRINT INK 4;AT 7,b
;x$: NEXT b
9161 FOR c=4 TO 14 STEP 5: PRINT INK 4;AT 8,c;y$: NEXT
c
9162 FOR d=4 TO 14 STEP 5: PRINT INK 4;AT 9,d;z$: NEXT
d
9163 PAPER 7: PRINT ;AT 20,27;" "
9164 PRINT INK 4;AT 11,27;" "
9700 RESTORE 9700: FOR a=USR "a" TO USR "r"+7
9701 READ user: POKE a,user
9702 NEXT a
9703 DATA 63,64,128,128,156,156,156,156,224,16,15,64,64
,0,136,136,0,0,192,32,16,16,16,16,156,156,136,65,62,16,
32,32,132,143,144,32,16,16,8,8: REM dog
9704 DATA 32,192,0,0,0,0,0,46,41,37,36,34,34,35,32,4,
4,4,132,132,132,132,4,32,16,15,29,57,177,251,123,8,16,2
24,128,128,176,240,192: REM dog
9705 DATA 6,5,7,8,16,224,160,96: REM bone
9706 DATA 37,22,12,126,246,255,124,12,12,61,63,63,29,88
,120,60: REM bird t & b
9707 DATA 0,0,0,0,0,156,254,255,0,0,28,191,255,255,255,
255,6,5,31,44,31,116,82,51,0,3,199,255,255,255,255,
0,28,191,255,255,255,255,255: REM hole,earth,arm,grass,
grass
9708 PRINT INK 0;AT 11,24;" " : AT 12,24;" "
9710 LET a$=" " : LET b$=" " : LET c$=" " : L
ET d$=" "
9711 RETURN
9999 SAVE "kkapers" LINE 1

```

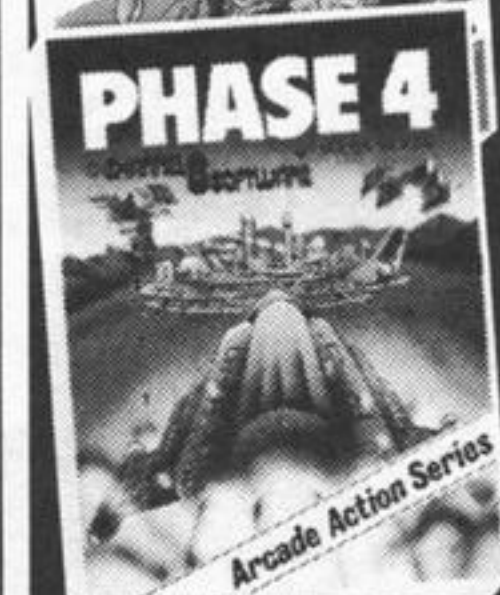
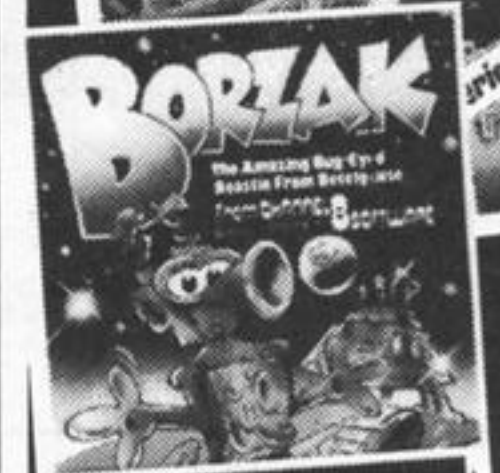
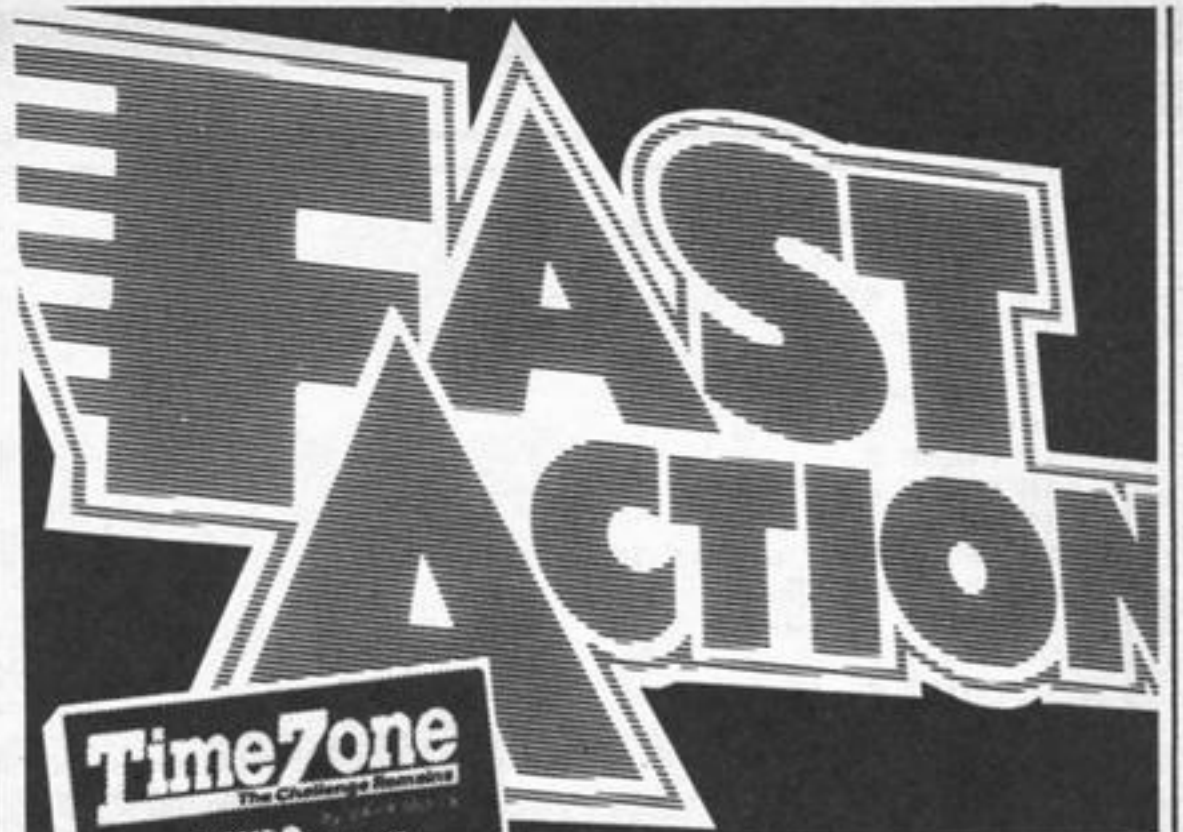

ARCADE GAMES FOR YOUR COMPUTER

TIME ZONE For Commodore 64

The dreaded Terrillon shape changers are attacking Earth again. It is your task to follow the Terrillon convoy from time zone to time zone, destroying as many enemies as possible. ONE or TWO players - JOYSTICK or KEYBOARD control.

BORZAK For Commodore 64 and Spectrum 48K

The amazing Bug-eyed Beastie from Betelgeuse After a 'slight' mishap in space Borzak floats down to earth many miles from his ship. He lands in a marsh and with your help has to survive the perilous journey back to his space craft.

PHASE 4 For Commodore 64

After defending your home planet from alien attack, you must follow the enemy through deep space to their fortress home, survive their city defences and take a final run over their inner communes. ONE or TWO players- JOYSTICK control.

ALSO THE FAMOUS



For ATARI, B.B.C., COMMODORE, DRAGON, ORIC/ATMOS & SPECTRUM.

ALL AT ONLY

£6.95

EACH

CHANNEL 8

SOFTWARE

51 Fishergate, Preston, Lancs PR1 8BH. Tel: (0772) 53057

Selected titles available from larger branches of Greens at Debenhams, Lewis's, and good computer shops everywhere, (in case of difficulty send P.O. or Cheque direct).

To Channel 8 Softwear, 51, Fishergate, Preston, Lancs.PR1 8BH. Please send me the following programs for my computer which is a

Total Games at £6.95. AMOUNT ENCLOSED £.....

CASH, CHEQUE P'O' ENCLOSED or ACCESS/BARCLAY CARD

Forward to:- No.....

Name.....

Address.....

Gold Digger BBC B £2.50

Firebird, Wellington Hse, Upper St, Martin's La, London WC2H 9DL

A good tune whilst you load to get you in the mood, appropriately enough it's Clementine. The graphics are to a very high standard and the instructions come on a well organised title page. Unfortunately there is only a keyboard option and that makes the game extremely difficult.

The game involves you, a miner, above ground waiting to start digging. A good point is that nothing happens until you commit yourself to moving down. Once you do all hell breaks loose. The gold is there and so are some helpful rocks. Helpful because close on your heels are misers who chase you.

There is very little time to think and plan although a pause key is included. This prevents the game from being a enjoyable by creating too much frustration early on. It is not just a challenge, it's a fight against the odds. A pity because if it could be slowed down or have a joystick option it might prove a winner.

instructions	100%
playability	30%
graphics	80%
value for money	60%



Space Pilot BBC £7.95

Superior, Dept C, Ground Floor, Regent Hse, Skinner La, Leeds 7

You are in control of a plane being attacked by enemy craft. Your plane stays in the centre while the enemy planes weave through clouds, shooting at you and releasing heat seeking missiles from time to time.

As you progress, you travel through different time zones to meet first world-war biplanes, second world war Spitfires, helicopters, jets and UFOs. Regular arcade goers should have recognised that this is a version of the arcade game Time Pilot which proved to be popular during the summer two years ago.

In this particular implementation, the graphics are clear and the animation is good. The way

in which the missiles track and the UFOs follow are particularly satisfying. The characters are strikingly close to the original and the sound effects are also convincing. The variety of enemy crafts and the differing tactics needed to defeat each wave also prolongs the appeal of this game.

The professional presentation — well up to the usual Superior standard — coupled with the incredible addictiveness makes Space Pilot a must for all shoot-'em-up fans.

instructions	65%
playability	95%
graphics	90%
value for money	65%



Rally Driver 48K Spectrum £9.95

Hill MacGibbon, 92 Fleet St, London EC4Y 7JY

This is an excellent simulation of a rally, complete with first class manual, and an essential map.

First you plan your route, enter drivers' names and the countdown begins. Your car's steering wheel is shown, and a speedometer. Using keyboard or joysticks you steer along a road through a nicely executed 3D landscape with trees, farms, cows on the road, and mud! Get too enthusiastic and you're off the road with a time penalty. Your driving technique must be tailored to current conditions or else!

You race against the clock and a bevy of talented drivers. Miss out a time check or passage control and the penalties amass. This is where the map reading and planning come in. By choosing the shortest route, and anticipating corners, time can be saved. You have to be really good to qualify for the next of the three stages.

This is a tricky, addictive and challenging game. A built-in save to Microdrive option means long loading can be avoided. Full marks but why the weedy sound? Perhaps the roar of an engine would have spoiled the graphics.

D.M.

instructions	100%
playability	100%
graphics	100%
value for money	90%



Careers guide

If you're wondering what to do when you leave school, look no further. Here are a few exotic careers you may like to choose from

Hit-Man 48K Spectrum £1.99

Scorpio Gamesworld, 307-313 Corn Exchange, Manchester 4

This is magic! On screen instructions in great detail give you the griff on this arcade strategy game.

You are hired by the Boss, depicted in style, to kill nine agents. You have £400 and you still have to buy your means of escape, and choose your weapon. Each has its pros and cons, so choose carefully! Fully illustrated instructions show what to expect.

Once you've chosen, a new screen is drawn with 3D blocks representing skyscrapers. Your opponent is there and, using the keyboard, you steer your man until the enemy hideout is revealed. You have a limited

number of informants. Once found, another hi-res screen unfolds, and you take aim as your target weaves and ducks. Hit him and you'll make your escape. Collect cash, and away for the next one!

What characterises this is the attention to detail. Instructions, graphics and sound are well executed and interesting. It is simple but effective, and fun to play. The best value for money I've ever seen, publishers of expensive stuff could learn from this. Highly recommended. D.M.

instructions	100%
playability	100%
graphics	90%
value for money	100%



Cavern Commander Atari 16K/32K £1.99

Scorpio Gamesworld, 307-313 Corn Exchange Building, Manchester

On receiving Cavern Commander I was immediately surprised by the low price. How could such a game be good. This is very good although it gets a little repetitive.

The object of the game is to navigate the dangerous caves of the planet Hesikos. You have limited fuel so time is of the essence. You then land your cruiser on the subterranean landing pads. Here you refuel before taking off to attempt another death defying journey. As well as missing jagged rocks you must avoid the poisonous gases floating around which can bring you to an untimely end.

Your cruiser is operated using the joystick. Graphics are good as are the sound effects. The only thing that irritates me is the poor choice of colours on some of the screens. One is shocking purple with a black background causing poor visibility. Thank goodness all the screens aren't similar or the game would be spoilt. There are two versions, a 16K version on side one and a 32K version on side two. Go ahead and try this, at this price you cannot lose.

D.W.L.

instructions	55%
playability	80%
graphics	80%
value for money	100%



Overdrive Electron £7.95

Superior, Regent Hse, Skinner La, Leeds 7

All the thrill of the Grand Prix without the curves is the feature of this game. You are in the cockpit of a Formula One racing car with plenty of speed and a fairly responsive wheel.

The problem is that the opposition come at you from the front if you are going fast enough. They can cause a very nasty crash if you aren't careful. As there are no bends you are not allowed to stray from this road and this means that your passing manoeuvres really have to be accurate or another chance for reincarnation is lost.

The game can be played on four different screens. By passing enough cars on the first screen you can get to the second

and so on. The first screen is normal enough, then comes night driving, snow conditions, where you spend a great deal of time sliding, and finally the desert.

The game is fast, responsive and easy to learn, having said all that there are other versions that have curves and these make the whole process much more interesting for the driver. **D.C.**

instructions	80%
playability	80%
graphics	85%
value for money	75%



Cyclone 48K Spectrum £6.95

Vortex, 280 Brooklands Rd, Manchester M23 9HD

Stunning is the word to describe these graphics. The game is so absorbing you lose track of time.

It's a 3D helicopter game, so the optional joystick is useful. Using shadow graphics, the ground is made to appear beneath you, and a complete set of instruments in the cockpit.

Houses, hills, fences and landing pads on which you refuel, are dispersed on islands, which can be shown on a map. You can even have an alternative view of the ground. Just to stop you getting bored between islands, there are low flying aircraft, and a cyclone which creates real flying hazards.

Warnings are shown on the instrument panel. Even the sound is good.

Flying is tricky, but when you get the knack, it's great! It's so good, I nearly forgot to write about the plot! Collect medical supplies, rescue people standing beneath waving at you, then return to Base Island. Not easy, in the sense that there's something to learn, but there's lots of enjoyment to be had in the learning. It's good when you fail! The best game I've seen in months. **D.M.**

instructions	100%
playability	100%
graphics	100%
value for money	95%



Strontium Dog: The Killing

Quicksilva, PO Box 6, Wimborne, Dorset BH21 7PY

If you ever fancied yourself as a Bounty Hunter, this could be for you. As the mutant Johnny Alpha, you're entered in a contest against the galaxy's killers in a giant maze. Search the maze, destroy all the aliens, then wipe out the Dictators who started the whole thing.

The graphics and sound are extremely good, though the aliens are the now standard collection of flying, twisting turning bits and pieces. They certainly pack a mean punch in fire power. You can fire back, of course, and you also have a new weapon, the electro flare.

The maze is massive, with its own set of co-ordinates, so a map is advised, as are certain techniques in the Bell Tower, which I never reached. Various joystick controls are provided, which is just as well, because the action is fast and furious.

Where this falls down is in originality. The story above may be new, but the structure is very similar to Atic Atac, colourful border round the screen enclosing one 'room' with exits out, blind alleys and so on. What a pity! **D.M.**

instructions	100%
playability	100%
graphics	100%
value for money	75%



Fun and games

There's something here for everyone, so dip in and see if you come up with a winner

ErBert BBC B £4.95

MicroByte Ltd, 18 Hilgrove Rd, Newquay, Cornwall TR7 2QZ

The arcade game of Q*Bert seems a popular choice for conversation to micros, with yet another one from MicroByte.

If there is anyone who hasn't seen the game, the theme is that of a pyramid of cubes round which Er*Bert hops, changing the surface colour until they all match. In this he has the help of transportation discs, which move him to the top, flying hats, which move him up or down two rows, and bananas, which increase scoring.

He must contend with gorillas, snakes, bouncing balls and black holes, all of which are intent on his downfall. The geometry of the screen changes on each level, and there is a choice of skill and

speed levels. I would recommend level 0 to start with, as it is quite difficult to master.

The graphics are particularly good, as are the sound effects, but I think if anything the game is a little too fast on the lower levels, and the controls are not all that responsive. Nevertheless, anyone who likes playing Q*Bert will like Er*Bert with its extra features. **D.A.**

instructions	35%
playability	65%
graphics	80%
value for money	70%



Computer Cluedo CBM 64 £12.95

Leisure Genius, 3 Montagu Rd, London W1H 1AB

Computer Cluedo is a version of the popular detective game by Waddingtons. It is a good implementation of a well tried and tested board game.

The object is to solve a murder mystery by specifying who killed Dr Black. The murder weapon and the location of the crime must also be found. You move from room to room and interrogate the other players you come across. Finally you should have eliminated everything except the answers to the game.

The program is extremely user friendly and cannot let you do anything wrong or cheat. You may have sound effects if you want them to help add interest. Other options allow you to specify the speed of the game the type of TV set that you are using (colour/b&w).

The screen contains some nice graphical displays and pictures which make playing Computer Cluedo a pleasure. Up to six people can play at once. This makes it ideal to keep the family amused.

The manual is good and easily understood. No loading problems were encountered at all but just in case there is, the product has a 12-month warranty. **K.I.**

instructions	75%
playability	85%
graphics	80%
value for money	80%



Blackjack

Show a flourish for cards with this game by Jonathan Fancey.
Beat the computer — or lose your money

All the rules of pontoon apply where the object of the game is to get as close to 21 without going over. The player (you) always goes first, the dealer being the VIC-20.

You are dealt with two cards at the start and can choose to take another by 'twisting'. Your total face value of the cards is shown above them and flashes during your go. If you get a five-card trick (five cards which

60000-60200 load graphics and machine code
62000-62030 clear variables for new game
63000 run out of money routine

equal 21 or less) you win instantly as you do if you get 21 or beat the VIC's total at the end of the hand. But the VIC always wins on the draw.

If you choose to 'stick' the VIC will have its go trying to accumulate as high a score as it dares. If you do win the hand you are given the option to gamble your original for four times as much as the original stake. But if you choose to collect you only get twice your stake added on to your total.

When you gamble you have to choose three cards of the five displayed. This is made more difficult by the fact that the cards are shown face down and only turn over when you choose them (it is always possible to get 21). But if you fail to get 21 with the three cards you win nothing and the original stake is lost to the VIC!

You start off with £100 and

- How it works**
- 1-6 DATA for cards and machine code routine
 - 5-199 initialization and setting of cards etc
 - 200-250 entering of player's bet
 - 300-2200 choosing card, recognizing it, printing it, twist or stick?
 - 2205-2260 another go subroutine
 - 3000-4000 computer's turn
 - 4000-4320 gamble or collect routine
 - 5000-6810 gamble routine, choosing cards to equal 21
 - 10000-10020 what suit card should be
 - 200000-50030 title page and entering of stick limit
 - 50000-59999 play Entertainer tune

- POKE codes**
- 36879 screen and border colours
 - 36878 volume for sounds
 - 36877 white noise
 - 36876 voice 1
 - 36875 voice 2
 - 36874 voice 3
 - 36869 high resolution pointer to graphics
 - 4096-4608 screen memory
 - 37888-38400 colour memory

- AYS card's suit
- CT computer's total
- TC amount of player's cards
- j9 number of cards in pack
- CF amount of money won
- TU player's money

Hints on conversion
This program uses very few POKE codes and is programmed mainly in ordinary Commodore BASIC. Therefore conversion to another machine should provide few problems as the machine code routine would need little attention.

- Controls**
- G gamble
 - C collect
 - T twist
 - S stick
 - H ace is high (equals 11)
 - L ace is low (equals 1)
- Type in bet with number keys and hit return afterwards.

you enter your bet by entering a number of pounds between £1 and £50. If you do not have the amount of money entered the message 'ABOVE' will appear and the bet must be entered again.

The game continues until you do not want another go or you run out of money.

- Variables**
- POS string of screen positioning for cards
 - YC your cards
 - AMS main pack of cards
 - RD amount of money to be won
 - NC number of cards
 - TT player's total of cards
 - A card chosen
 - AZS type of card (3,JACK,ACE etc.)

Note: Part 1 of the program changes the start of BASIC to protect defined characters in the main program, and therefore must always be loaded first, before the main program.

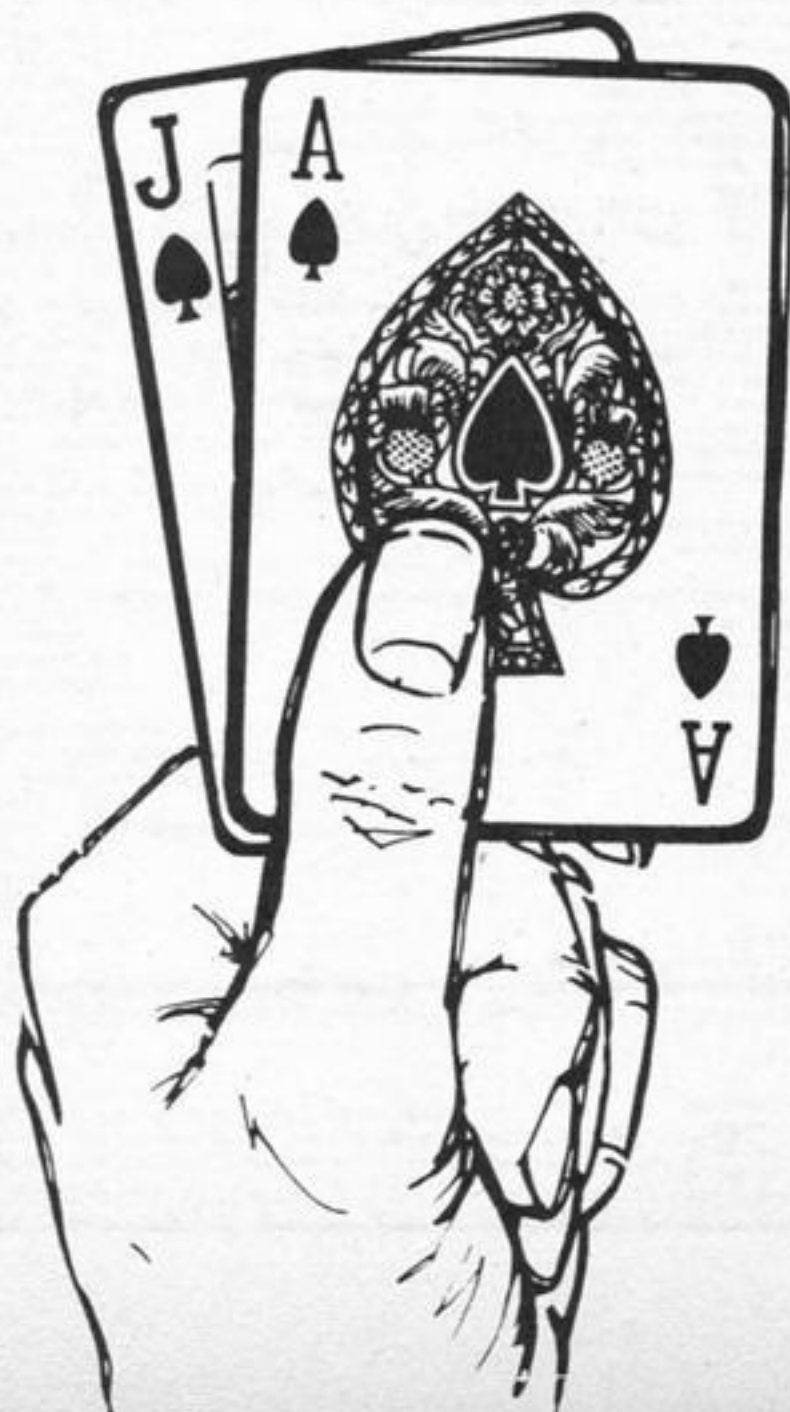

Listing 1

```

4 POKE36867,30
5 POKE36865,52
10 PRINT"J"
20 POKE36879,230
40 A=PEEK(37151)
50 IFA=62THEN70
55 PRINT"*****PRESS PLAY ON TAPE*"
56 FORB=1TO100:NEXT
57 PRINT"J"
58 FORB=1TO100:NEXT
60 GOTO40
70 PRINT"*****BLACKJACK*"
71 PRINT"*****PLEASE WAIT*"
72 PRINT"*****PROGRAM IS LOADING*"
73 PRINT"*****BY JONATHAN FANCEY*"
74 PRINT"*****COPYRIGHT 1984*"
75 PRINT"*****PROGRAM IS LOADING*"
76 PRINT"*****PLEASE WAIT*"
110 PRINT"*****BLACKJACK*"
120 POKE198,7:POKE631,76:POKE632,207:POKE633,159:POKE634,13:POKE635,82:POKE636,2
13
130 POKE637,13
140 POKE43,1:POKE44,34
    
```

Listing 2

```

1 DATA9,12,20,D2,FF,A9,13,20,D2,FF,A9,1E,20,D2,FF,A9,50,80,0F,90,A6,00,A2,00,E8
,A9
2 DATA20,20,D2,FF,E0,FC,D8,F6,C8,C0,02,00,0F,A9,1D,8D,0F,90,60,*
3 DATA255,126,226,197,197,193,194,124,255,129,66,36,24,36,66,255,62,67,131,163,1
63
4 DATA71,126,255,3,12,16,16,16,16,12,3,192,48,0,0,0,0,48,192
5 POKE36879,187
6 POKE36864,12:POKE36865,38:POKE36866,22:POKE36867,46
10 PRINT"J"
20 PRINT"*****PLEASE WAIT*"
23 PRINT"*****DATA BEING INITIALIZED*"
24 PRINT"*****PROGRAM WILL RUN IN*"
25 PRINT"*****ABOUT 1 AND 1/2 MINS*"
40 POKE36869,205
93 GOSUB60000
95 TC=0:TU=100:POKE1816,TU
96 GOTO20000
97 AMS="19101010202020203030304040405050506060607070708080809090900"
-
98 POKE36869,205:TB=PEEK(1817)
    
```

Star Warp 32K BBC £7.95

Superior, Regent Hse, Skinner Lane, Leeds 7

This game is rather old hat and I am surprised that Superior were prepared to put their name to it. It is a 3D space game in which you have a sight and there are huge numbers of fast moving space ships to shoot.

They appear as if from nowhere and deliver a number of laser blasts to your ship before disappearing again. The limit is the amount of protection from the blasts that your shields offer each one taking its toll. Another limiting factor is the temperature of your weapon. If this climbs too high you are left stranded without any defence until they cut in again. In all there is a great deal of action and little originality.

It would have been improved if you had been piloting the ship instead of just aiming the sights. The graphics are good, steady and quite interesting but even this cannot raise the game above the mediocre. If it hadn't been done several times before I might enthuse but this is far too late to make any impact at all. **D.C.**

instructions	85%
playability	60%
graphics	75%
value for money	55%



Jack & the Beanstalk

Superior, Regent Hse, Skinner Lane, Leeds 7

Pantomime time again but I didn't expect the software companies to come in on the act. This is a well disguised ladder and level game in which you play Jack, chased by the unfriendly giant.

The first screen shows the bean stalk growing from the beans and you can climb it if you wish. On the way up there are smoke clouds from the chimney which cause you to fall off the stalk if you climb through them. If you make it to the castle of the hungry giant then there is a race of terror snails to be overcome. This is done using the 'pickup the axe and dig a hole' technique. I would just have trodden on them.

The giant doesn't seem too hungry because he runs far too quickly and gets nasty if you take his gold. As this is the general aim of the exercise you don't have much choice.

The 16 colour graphics are very good and the action fast and furious, pity there aren't more screens. The interesting sound adds to the enjoyment too. A great game for all the family. **D.C.**

instructions	90%
playability	95%
graphics	90%
value for money	90%



Airlift 32K BBC £7.95

Superior, Regent Hse, Skinner Lane, Leeds 7

There used to be a television programme called Whirly Birds that most of you are too young to remember. The two pilots of the helicopter always did their best to make sure that anyone who needed help got it, usually just in the nick of time.

This program has a similar theme, you have to help homeless people to safety. You do this by landing your helicopter as near to them as possible and transporting them to the red cross post which is your base. They are made homeless by drivers of tanks who seem to take delight in destroying their pleasant, playschool style, homes. You can bomb the tanks, although aiming is difficult, but if you bomb a hostage you lose points, quite right too.

Added to all this there are the auto gyro and the killer satellite but I have to admit that they haven't appeared yet. The scrolling effect is interesting with a multi-plane camera effect but the game is boring after a number of plays.

Graphically good I expected a little more from the writer of Overdrive. **D.C.**

instructions	75%
playability	80%
graphics	90%
value for money	80%



Beeb bonanza

Fairy tales of flight and fantasy. It's all here on this page exclusively for Beeb owners

Devils Causeway 32K BBC £6.95

This is one of those games where the picture on the cassette cover is the best feature of the whole package. If this game had been printed as a listing, for it is entirely BASIC, in a magazine then you would have been pleased with the result. It is being sold at nearly seven pounds and this is ridiculous for a game of this standard.

The aim is to walk along a path towards an exit in the opposite corner of the screen. On the way you meet a number of characters who each challenge you for one of your lives.

One will ask you to add up a series of numbers in a very short time, another wants you to shoot a moving blob, a third requires a password that is flashed on the

screen and another moves you around the path. Step off the path and you're dead too.

An interesting idea that can be fun but is ludicrously over priced. For this sort of money you can expect a full machine code game. **D.C.**

instructions	65%
playability	40%
graphics	15%
value for money	15%



Galactic Patrol 32K BBC £6.95

Warlock Software

Just when you thought it was safe to run to your space craft, the alien fleet appears and proceeds to run amok, killing the poor spacemen by the dozen.

Thsu starts this game which is more like five games in one. The second screen involves defending a transporter and the third requires docking skills. The fourth involves running the gauntlet of friendly defence systems, and finally you need to dock and let the colonists disembark from your ship.

There are five levels of difficulty to the game, meaning that you have to go round the game five times before you have seen it all.

The graphics are good with plenty of colour and interest, although it would have been nice to have different alien shapes. The problem is that the movement routines show more flicker than one might expect and this makes the game harder to play.

Unfortunately this game doesn't have that addictive quality that we all look for. I can happily walk away from it without a moment's hesitation and that is not what I expect from a top flight game today. **D.C.**

instructions	75%
playability	70%
graphics	80%
value for money	75%



This article by Nick Godwin shows you how to delve into the resources of your ZX81. You may be surprised at what you find

Three ROM tables and some simple addition

Every now and then I like to dip into the Sinclair ROM to see what I can find. It can be very rewarding. My technique for doing this is simply to switch on the machine and enter the following three-line program:

```
10 FOR J=0 TO 8191
20 PRINT J;TAB 8;PEEK J,CHR$ PEEK J
30 NEXT J
```

Once this has been RUN, I can BREAK it at any time and, using the command, LET J = n-1, where n = the first address I wish to view, followed by CONT, pick up the ROM wherever I like.

A couple of tables came to my notice recently, both concerned with the interpretation of the keyboard. The

first can be used to translate a key code to the code of the FUNCTION character which appears on that key (e.g.: the FUNCTION character on key "A" is ARCSIN). The table starts at address 126 and, with a few gaps, extends to address 164. The following routine demonstrates its effect:

```
10 FOR J=126 TO 164
20 LET J=J+(J=129 OR J=155)+10*(J=140)+2*(J=160)
30 PRINT J;TAB 8;CHR$ PEEK J,C
HR$ PEEK (J+78)
40 NEXT J
```

RUN, and compare columns two and three with the keyboard.

The second table is similar,

but is concerned with finding the GRAPHICS character appropriate to each key. Here is a demonstration routine:

```
10 FOR J=169 TO 198
20 LET J=J+2*(J=184)+4*(J=189 OR J=194)
30 PRINT J;TAB 8;PEEK J,CHR$ PEEK J;TAB 24;CHR$ PEEK (J+74)
40 NEXT J
```

You will notice that on this one I have included the code of the key character (second column). The reason for this is that some of the keys concerned do not have a corresponding printable character (e.g. the code for EDIT is 117). Which keys these are can be ascertained by reference to

Appendix A of the ZX81 User Manual.

While on the subject of translating keys, we can see also that this can be done with respect to keywords. In this case, however, no ROM table is involved, just some simple addition, as the following routine demonstrates:

```
10 FOR J=38 TO 63
20 PRINT CHR$ J,CHR$ (J+192)
30 NEXT J
```

That routine shows that the code of a keyword can be found by adding 192 to the code of the

key on which it appears.

Finally, still on the subject of keywords, it can sometimes be

useful to convert a keyword into its component characters (e.g. convert the keyword "PRINT" to its component characters: P,R,I,N & T). The

following program demonstrates how a ROM table starting at address 274, through 495, can be used to do this for most keywords:

```
10 LET K=273
20 FOR J=192 TO 255
30 LET K=K+1
40 PRINT CHR$ J,
50 FOR K=K TO 32767
60 PRINT CHR$ (PEEK K-(128 AND PEEK K>64));
70 IF PEEK K<64 THEN NEXT K
80 PRINT
90 NEXT J
```

A study of these tables and techniques can yield useful results in terms of making programs more user-friendly by enabling appropriate keys to produce responses relating

to FUNCTIONS, GRAPHICS characters, or keywords as appropriate, thus dispensing, sometimes, with the need for a menu or for complicated program instructions.

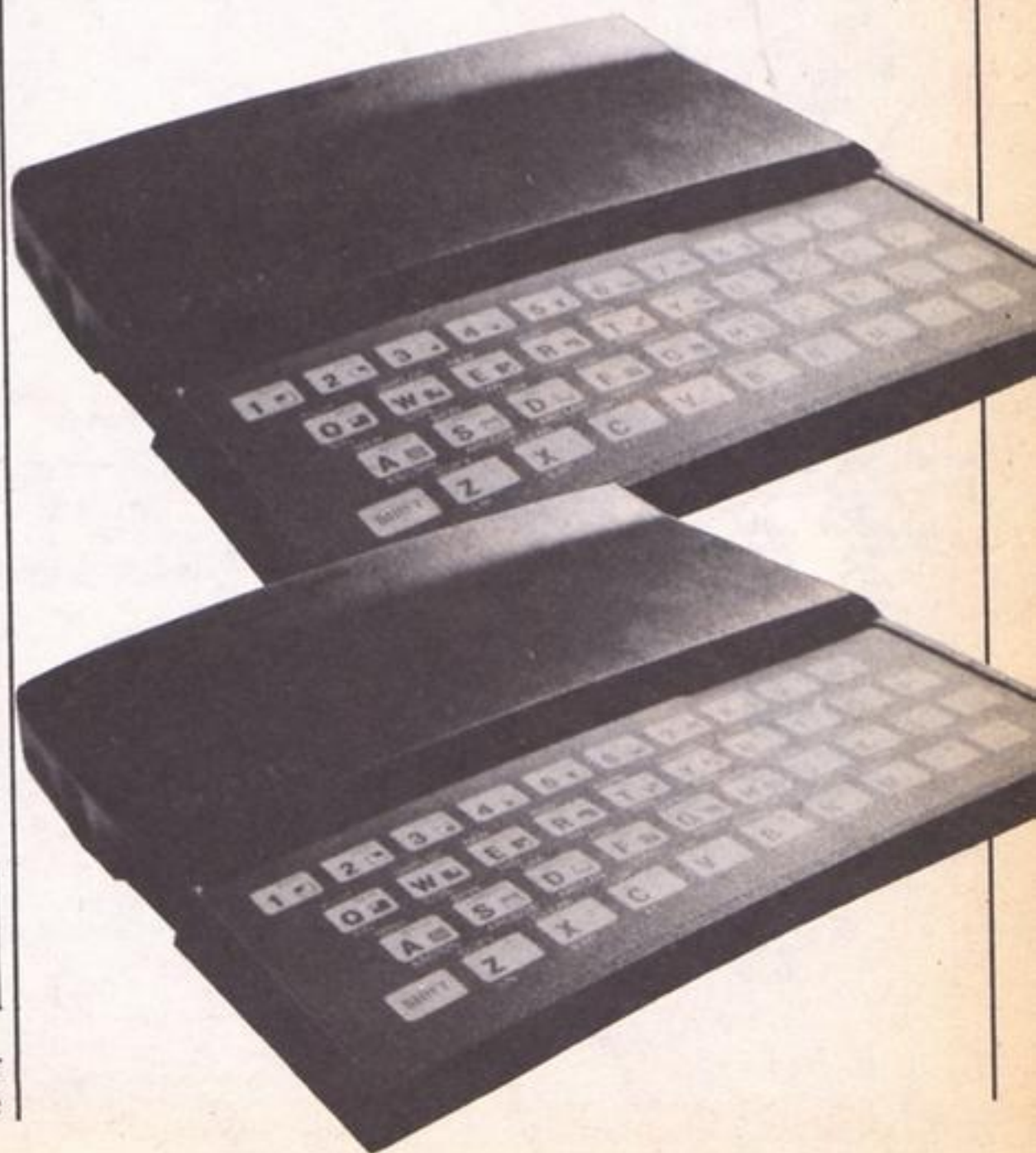

Your one chance of survival is to raze those tower blocks to the ground — otherwise your plane will crash and you'll perish!

By Russell Wooberry

Bomb those sky-scrapers!

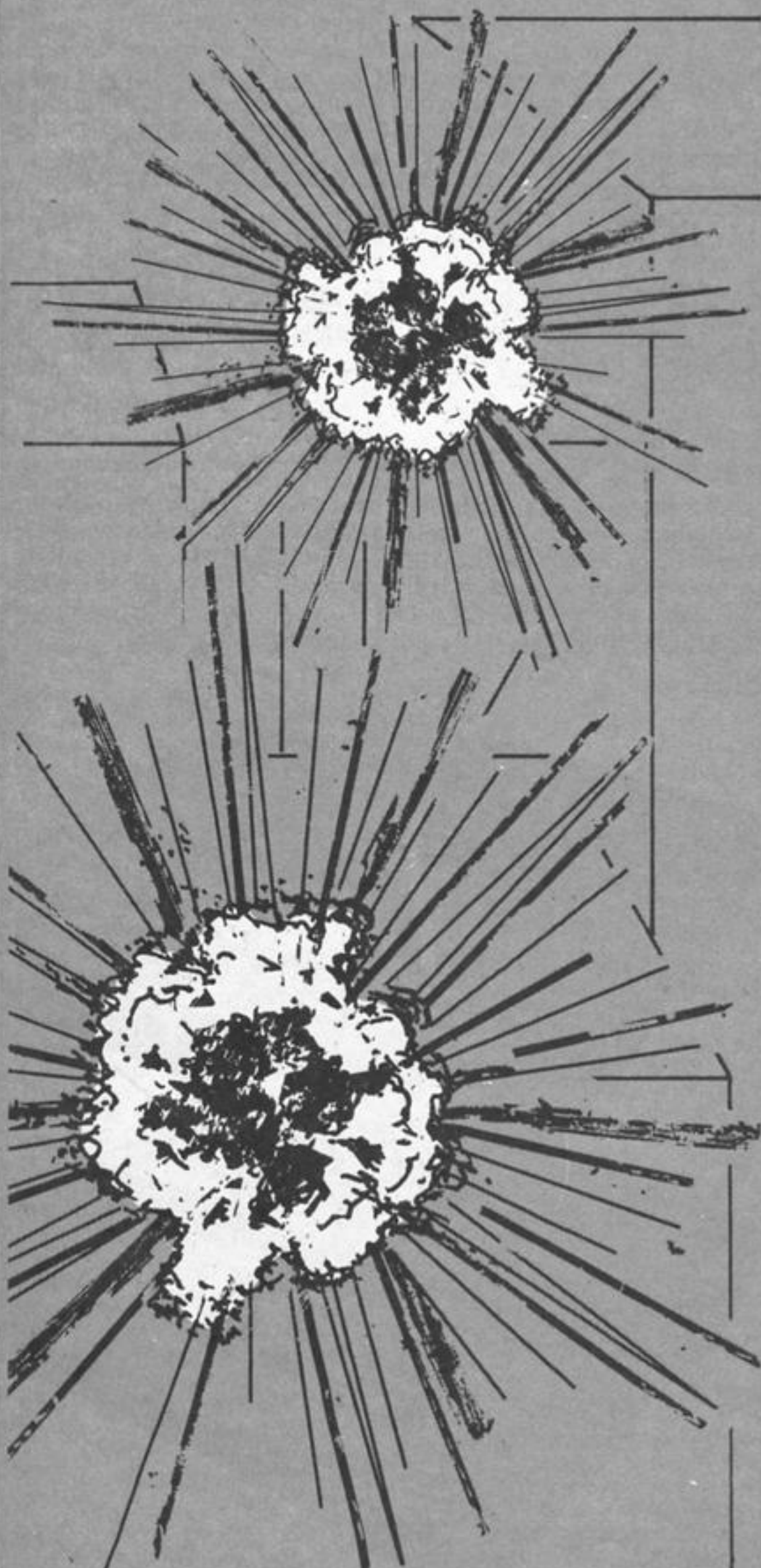

As the pilot of a plane, you are flying over a city of tower blocks. Your plane keeps losing height and you have no option but to try to land.

However there is a drawback — to do so you must bomb the tower blocks. You can release a bomb by pressing any key, but only one bomb may be on screen at any one time. If you succeed you will land safely on the ground.

Variables

- K** logs plane's position for the horizontal position of bomb
- L** length of drop for bomb
- P** determines whether or not a bomb is being dropped: 1 = yes, 0 = no
- J** vertical position of plane
- I** horizontal position of plane

Hints on conversion

Conversion to other micros should not be too difficult, except that to save memory I used code statements.

The character in quotes refers to the character number which can be found in the back of the ZX81 manual.

I used PEEK 16398+256X PEEK 16399 to check for collisions, and SCROLL to scroll the screen upwards one character. Other micro owners will have to find other commands.

How it works

- 1-7 initialise variables, print tower blocks
- 8-9 loops for moving plane
- 10-11 checks for collision
- 12 prints plane
- 13 checks if bomb is being dropped
- 14-16 moves bomb
- 17-19 loops back round
- 20 landed
- 21 if you're not pressing a key, returns to main section
- 22-25 sets up bomb variables and returns to main section

```

1 LET P=PI-PI
2 PRINT AT CODE "?",PI/PI;"███
3 FOR J=PI/PI TO CODE "?"
4 FOR I=CODE ":" TO RND*CODE
5 PRINT AT I,J;"█"
6 NEXT I
7 NEXT J
8 FOR J=CODE " " TO CODE ":"
9 FOR I=PI-PI TO CODE ":"
10 PRINT AT J,I+PI/PI;
11 IF PEEK VAL "(PEEK 16398+25
6*PEEK 16399)"=CODE "█" THEN STO
P
12 PRINT AT J,I;" >"
13 IF P=PI-PI THEN GOTO CODE "
+"
14 PRINT AT L,K;".";AT L,K;" "
15 LET L=L+PI/PI
16 IF L=CODE "?" THEN LET P=PI
-PI
17 NEXT I
18 PRINT AT J,I;" "
19 NEXT J
20 STOP
21 IF INKEY$="" THEN GOTO CODE
)"
22 LET P=PI/PI
23 LET K=I+PI/PI
24 LET L=J
25 GOTO CODE ":"
    
```

Money is the theme of this program by David Bridge. Collect the £s and get rich quick

Money maze

This is a game for budding Ebenezer Scrooges. Your aim is to eat as many £ signs as you can without bumping into anything white.

The game has five stages. Stage one is fairly easy but stage five is virtually impossible so you'll need a lot of practice.

Hints on conversion

The CBM 64 has a 100 screen (40 column x 25 lines). The screen starts at 1024 so the numbers 1484+M are co-ordinates for the centre of the screen. If your computer has a 1000 character-screen, find out its start position and add 450 to give value substitute for 1484.

POKE 53281,0 turns the screen black. **53280** turns the border black. **PRINT CHR\$(14)** puts the CBM 64 in lower case and (142) in upper case. Subroutine **6000** finds position of joystick and whether the fire button has been pressed and increments R accordingly.

All **POKEs** in lines 58-110 are for screen manipulation, while **80-95** draw a border line in white.

55296 and the next 1000 memory locations are the colour memory map. **POKE 1024,156**: **POKE 55296,14** puts a blue £ in the top left corner.

You have four lives and if a stage gets too difficult you can go on to the next one. The only problem with this is that your player slows down so don't try it too often.

First you are faced with brief instructions and asked to pick a

Variables

- M+1484** position of player
- R** amount to increment M by to find new position
- J** lives lost
- L** money picked up including bonus
- F** money dropped
- S** money left
- B** bonus
- G** speed of player
- H** rate of speed increase
- Q** skill levels
- P** £s

level. Type in a number from one to five but don't press return. You can use joystick or keyboard and moving to the gap at the top of the screen lets you know your score and allows you to move on to the next stage.

Note: Type in, save and run the program. Saving before running is important because the program contains **POKEs**. Typing a wrong value may cause the computer to crash thus destroying the program.

How it works

- 0** select lower case characters
- 1-53** print instructions, set all variables to 0, make screen black
- 55** select upper case characters
- 56-130** set up screen
- 200-290** get movement and work out next position, check if valid move
- 3000-3002** count up players so

- far
- 3006-3060** print score
- 5000-7030** prints instructions
- 8000-8100** pick skill level, work out new levels throughout game
- 10000-10050** score so far, when

- men are lost
- 13005-13770** hall of fame results
- 16000-16070** get direction of joystick
- Controls:** J up, M right, N left, space bar down. Alternatively you could use joystick in port 2.

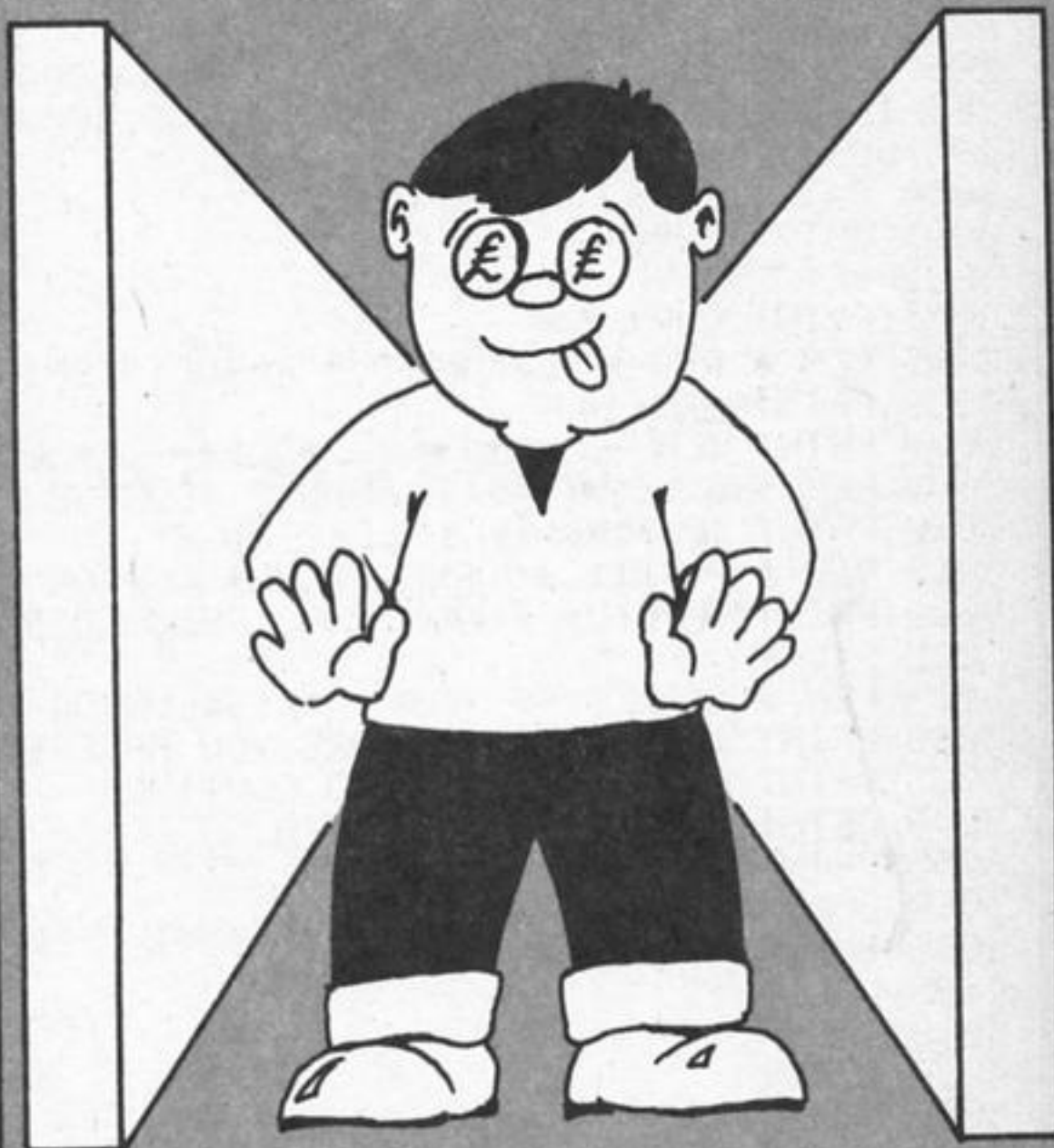

```

0 PRINT CHR$(14)
2 PRINT CHR$(142)"YOU ARE——— 'e'":FOR T= 1 TO 2000:NEXT:REM SHIFTED,0
3 L=0:B=-2:PRINT"J"
4 B=-2:U=0
5 POKE 53281,0:POKE53280,0
50 DIM A(500),B(500)
53 J=0
55 PRINT CHR$(142)
56 PRINT"J"
58 FOR I=1 TO P:LET A(I)=INT(1000*RND(1)+1):NEXT
60 FOR I= 1 TO P:POKE1024+A(I),160:POKE55296+A(I),1:NEXT
70 FOR I=1 TO P-5:LET B(I)=INT(1000*RND(1)+1):NEXT
75 FOR I= 1 TO P-5:POKE1024+B(I),156:POKE55296+B(I),14:NEXT
80 FORI=1TO40:POKE1023+I,160:POKE55295+I,1:POKE56255+I,1:POKE1983+I,160:NEXT
90 FORI=1TO920STEP40:POKE1063+I,160:POKE55335+I,1:POKE55374+I,1:POKE1102+I,160
    
```

```

95 NEXT
100 FOR I=1 TO 8:POKE1039+I,96:NEXT
105 FOR I=1 TO 16:POKE1063+I,160:POKE55335+I,1:NEXT
106 FOR I=1 TO 16:POKE1087+I,160:POKE55359+I,1:NEXT
110 POKE1079,105:POKE1088,95:POKE 55351,1:POKE 55360,1
115 REM *HOME CURSOR *CURSOR RIGHT 30 TIMES *
120 PRINT"#####LEVEL"0
122 REM *HOME* RIGHT 3 TIMES
125 PRINT"#####PLAYER";J+1
130 IFJ<1 THEN PRINT"#####PLAYER 1"
190 :
200 M=0:R=0
210 POKE 1484+M,81:POKE55756+M,7
212 FOR T= 1 TO 6:NEXT
220 GOSUB16000
270 GETA$
271 IF A$=CHR$(13)THEN R=0
272 IF A$="J" THEN R=-40
274 IF A$=" " THEN R=40
276 IF A$="M" THEN R=1
278 IF A$="N" THEN R=-1
280 POKE 1484+M,102:POKE 55756+M,6
282 F=F+2
284 M=M+R
285 IF PEEK(1484+M)=96 THEN 10000
286 IF PEEK(1484+M)=160 THEN GOSUB 3000
288 IF PEEK(1484+M)=156 THEN GOSUB 4000
290 GOTO 210
3000 J=J+1:IFJ>3 THEN 3006
3001 GOTO 11000
3002 RETURN
3004 PRINT CHR$(14)
3005 REM * RVS * HOME*RED * RESULTS(SHIFTED)* SHIFTED ASTERISK *THEN RESULTS ETC
3006 PRINTCHR$(14)
3007 PRINT"#####"
3009 REM *YELLOW*CURSOR DOWN 2 *CURSOR RIGHT 4 *SHIFTED T *
3010 PRINT"#####YOU COLLECTED £";L
3019 REM * PURPLE *CURSOR DOWN* CURSOR RIGHT * SHIFTED T
3020 PRINT"#####HIS AMOUNT WAS REDUCED BY£ ";F"DUE TO DROPPING IT BY WALKING"
3025 S=L-F
3029 REM * COMMODORE AND 1 *RVS*CURSOR DOWN*CURSOR RIGHT*SHIFTED T
3030 PRINT"#####HEREFORE YOU HAVE £";S"LEFT"
3035 PRINT"PRESS ANY KEY TO CONTINUE"
3040 GETA$:IF A$="" THEN 3040
3055 PRINT"J"
3060 GOTO 13000
4000 B=B+5
4005 L=L+50+B
4010 G=G-H
4020 RETURN
5000 POKE53281,0:POKE53280,0
5001 GOSUB 7000
5029 REM *CURSOR DOWN 2 * RIGHT 4 *SHIFTED Y
5030 PRINT"#####YOUR AIM IS TO EAT ALL THE SQUARES MARKED #####, AND TO ";
5035 PRINT"AVOID HITTING THE ";
5040 PRINT"WHITE SQUARES #####. HITTING A WHITE SQUARE WILL RESULT IN ";
5050 PRINT"LOSS OF LIFE AS WILL HITTING A WALL";
5059 REM * CURSOR DOWN 1 RIGHT 3 * SHIFTED E
5060 PRINT"#####EACH TIME YOU HIT A ##### SQUARE YOUWILL RECEIVE AN AMOUNT ";
5070 PRINT"OF MONEY. THIS AMOUNT WILL INCREASE EACH TIME, HOWEVER YOUR ";
5080 PRINT"PLAYER WILL SPEED UP."
5089 REM * CURSOR DOWN 2 RIGHT 3 * SHIFTED W
5090 PRINT"#####WHEN YOU HAVE COLLECTED THE MONEY, YOU MUST GO TO THE SPACE AT";
6000 PRINT"THE TOP OF THE SCREEN WHERE YOU WILL PROCEED TO THE NEXT STAGE."
6100 PRINT"#####PRESS (F1) TO GO ON OR (F3) TO PLAY "
6150 GET A$:IF A$=" " THEN6200:REM * F1 IN SHIFTED 2
6160 IF A$=" " THEN 8000:REM F3 IN SHIFTED 2
6170 GOTO6150

```

```

6200 GOSUB 7000
6299 REM * YELLOW * DOWN 1 * RIGHT 4 * SHIFTED Y
6300 PRINT"YOU MAY PICK SKILL LEVELS 1 TO 5 "
6309 REM * DOWN 2 * RIGHT 1 *SHIFTED Y
6310 PRINT"YOU HAVE FOUR LIVES, AND WILL BE TOLD YOUR SCORE EACH ";
6320 PRINT"TIME YOU LOSE ONE."
6329 REM * DOWN 1 * RIGHT 1 *SHIFTED M
6330 PRINT"MOVING TO A NEW SCENE WILL RESULT IN MORE OBSTACLES BEING ";
6340 PRINT"PRODUCED"
6700 REM * DOWN 1 * BLUE * RVS * YELLOW *RVS OFF *
6800 PRINT"PRESS ANY KEY TO PLAY "
6810 GET A$:IF A$="" THEN 6810
6820 GOTO 8000
6999 REM [CLR HOME] [RVS] [YELLOW] [39 SPACES]
7000 PRINT"
7004 REM [RVS] [PURPLE] [39 SPACES]
7005 PRINT"
7010 PRINT"    RULES FOR PLAYING MONEY MAZE
7020 PRINT"
7025 PRINT"
7030 RETURN
7999 REM * CLR HOME *DOWN 3 RIGHT 4 *
8000 PRINT"CHOOSE YOUR SKILL LEVEL"
8010 GET A$:IF A$="" THEN 8010
8020 Q=VAL(A$)
8030 ON Q GOTO 8050,8055,8060,8065,8070
8050 LET G=300:H=10:P=20:GOTO 8100
8055 LET G=300:H=20:P=25:GOTO 8100
8060 LET G=250:H=15:P=25:GOTO 8100
8065 LET G=250:H=20:P=30:GOTO 8100
8070 LET G=200:H=20:P=40:GOTO 8100
8100 RETURN
9999 REM * HOME CURSOR *
10000 PRINT"YOUR SCORE SO FAR IS"L-F
10010 Q=Q+1:R=0:IFQ=6 THEN Q=5
10020 GOSUB 8030
10030 FOR T= 1 TO 2000:NEXT
10050 GOTO 55
10999 REM * HOME CURSOR * DOWN 1 RIGHT 1 * RVS *
11000 PRINT"THAT IS NOT ALLOWED"
11001 REM * HOME CURSOR * DOWN 2 RIGHT 1 * RVS *
11002 PRINT"YOU LOSE 1 LIFE"
11005 FORI= 1 TO 2000:NEXT
11009 REM * WHITE * HOME * DOWN 1 RIGHT 1 * 14 SPACES * SHIFTED £ *4 SPACES *
11010 PRINT"
11014 REM *YELLOW * HOME * DOWN 2 RIGHT 1 *15 SPACES *
11015 PRINT"
11016 FOR I=1 TO 15:POKE1063+I,160:POKE55335+I,1:NEXT
11017 POKE1484+M,160
11019 REM * HOME * RIGHT 3 *
11020 M=0:R=0:PRINT"PLAYER"J+1
11030 RETURN
12349 REM * SHIFTED ASTERISK * SPACE 1 * SHIFTED Q *
12350 PRINTCHR$(142)"YOU ARE _____"
13000 C(10)=6
13004 REM * CLR HOME * RIGHT 10 *SHIFTED HALL OF FAME *
13005 PRINTCHR$(14)"HALL OF FAME":B$="":Y=0
13009 REM DOWN 2 * RIGHT 3 * SHIFTED ENTER YOUR NAME *
13010 PRINT"ENTER YOUR NAME"
13019 REM * DOWN 1 RIGHT 2 *
13020 PRINT"TYPE ^/ TO FINISH"
13030 GET A$:IF A$="" THEN 13030
13035 Y=Y+1
13040 IF A$="^/" THEN 13500
13045 IF A$=CHR$(13)THEN 13500
13050 IF Y>15 THEN 13500
13055 B$=B$+A$
13056 REM * HOME * DOWN 6 RIGHT 4 *

```

COMMODORE 64 PROGRAM

```

13057 PRINT "          " B$
13060 GOTO 13030
13500 C$(10)=B$
13510 GOSUB 13700
13549 REM * NAME * 10 SPACES * SCORE * 9 SPACES * POSITION *
13550 PRINT "  /  \      *  -  *      T  /  \  "
13570 FOR E= 1 TO 10
13580 PRINTC$(E);TAB(14)C(E);TAB(30)E: NEXT
13660 PRINT "PRESS ANY KEY TO CONTINUE"
13665 GET A$: IF A$="" THEN 13665
13680 GOTO 1
13700 FOR E= 1 TO 9:FOR U= 9 TO 1 STEP -1
13710 IF C(U+1)<C(U) THEN 13750
13720 D=C(U):D#=C$(U)
13730 C(U)=C(U+1):C$(U)=C$(U+1)
13740 C(U+1)=D:C$(U+1)=D$
13750 NEXT: NEXT
13770 RETURN
16000 A=15-(PEEK(56320)AND15)
16005 B=PEEK(56320)AND16
16007 IF B=0 THEN R=0
16010 IF A=1 THEN R=-40
16020 IF A=2 THEN R=40
16025 IF A=4 THEN R=-1
16030 IF A=5 THEN R=-41
16035 IF A=6 THEN R=39
16040 IF A=8 THEN R=1
16045 IF A=9 THEN R=-39
16047 IF A=10 THEN R=41
16050 RETURN
16060 GOTO 16000
    
```

POOLSWINNER

THE ULTIMATE POOLS PREDICTION PROGRAM

- **MASSIVE DATABASE** Poolswinner is a sophisticated Pools prediction aid. It comes complete with the largest database available - 22000 matches over 10 years. The database updates automatically as results come in.
- **PREDICTS** Not just SCOREDRAWS, but ALWAYS, HOMES and NO SCORES.
- **SUCCESSFUL** SELEC guarantee that Poolswinner performs significantly better than chance.
- **ADAPTABLE** Probabilities are given on every fixture - choose as many selections as you need for your bet. The precise prediction formula can be set by the user - you can develop and test your own unique method.
- **SIMPLE DATA ENTRY** All English and Scottish team names are in the program. Simply type in the reference numbers from the screen. Or use FIXGEN to produce fixture list automatically (see below).
- **DISC/MICRODRIVE COMPATIBLE** All versions (except Apple and IBM) are supplied on tape, with simple instructions for conversion to disc/microdrive operation. (This seasons results are supplied with the package so that predictions can start immediately.)



Boxed, with detailed instruction booklet

AVAILABLE FOR Spectrum (48K), Commodore 64, VIC 20 (+16K), AMSTRAD CPC 464, BBC B, Atari (48K), ZX81 (16K), Dragon, Apple II, IBM pc

PRICE £15.00 (all inclusive)

NEW

FIXGEN 84/5

AT LAST! No more struggling for hours to get the fixture list into the computer. FIXGEN has been programmed with all English and Scottish fixtures for 1984/5. Simply type in the date, and the full fixture list is generated in seconds. Fully compatible with Poolswinner.

POOLSWINNER with FIXGEN £16.50 (all inclusive)
Fixgen alone £5.50



COURSEWINNER v3

THE PUNTERS COMPUTER PROGRAM

Coursewinner is designed to allow you to develop and test your own unique winning system. Using information from daily newspapers or 'Sporting Life', the most important factors can be input and analysed. The program is supplied with a database detailing best trainers and jockeys, and effect of the draw for all British courses. (Flat & National Hunt.)

AVAILABLE FOR Spectrum (48K), Commodore 64, BBC (B), Dragon, Atari (48K), Apple II

PRICE £12.50 (all inclusive)

AVAILABLE (RETURN OF POST) FROM ...



phone 24 hrs



SOFTWARE



phone 24 hrs

37 COUNCILLOR LANE, CHEADLE, CHESHIRE. ☎ 061-428 7425

SOLID STATE SOFTWARE

TEXAS INSTRUMENTS

Extended Basic	69.25
Minimemory	59.95
Personal Record Keeping	22.50
Home Budget Management	17.50
Adventure/Pirate	22.00
Buck Rogers	19.95
Burgertime	19.95
Hopper	14.95
Jawbreaker II	14.95
M.A.S.H.	14.95
Moon Mine	14.95
Munchmobile	14.95
Parsec	17.50
Return to Pirate Isle	19.95
Sneggit	14.95
Star Trek	19.95

MODULES UNDER £10!

- *Zero zap
- *Video Games 1
- *Tombstone City
- *Connect 4
- *Chisholm Trail
- *Car Wars
- *The Attack
- *A-maze-ing
- *Hustle

*OUR PRICE £9.95

ATARI SOFT for TI-99/4A

Donkey Kong	20.00
Jungle Hunt	18.00
Moon Patrol	20.00
Ms. Pacman	18.00
Picnic Paranoia	12.50
Pole Position	24.50
Protector II	18.00

+ many more modules in stock.

PARCO Electrics

Software for the TI-99/4A

CASSETTE SOFTWARE

PARCO Software

Hop On	5.95
*Listfile (database)	9.75
*Parco Golf	7.95
Space Trek	5.95
*Superhod	7.95
(* Extended basic.)	

*Parco Pak²
4 games in library case

VIRGIN Games

Robopods	4.95
Fun-Pac	4.95
Fun-Pac 2	4.95
Fun-Pac 3	4.95

All 4 above in library case

COLLINS Educational

Cassette AND Manual in each.	
Starter Pack 1	5.95
Starter Pack 2	5.95
Games Writer Pack 1	5.95
Games Writer Pack 2	5.95

All 4 above + free
basic tutor cassette

*** Super Sketch
now available at £59.95!!!

+ many more tapes in stock.

For a free price list and further information send a s.a.e. to:

**4 DORSET PLACE, NEW STREET, HONITON
DEVON EX14 8QS. TELEPHONE (0404) 44425**

Access orders taken by telephone.
All prices are inclusive VAT and p&p.

Ewgeebez BBC £2.99

Software Projects, Bearbrand Complex, Allerton Rd, Woolton, Liverpool LS25 7SF

Zelob the Melkon has been marooned on the space station Ewgeebez. To escape, he must collect 12 power crystals to activate the main teleport which he must find in the mass of corridors. Easy enough task — except for the alien creature which regularly teleports in from neighbouring foreign planets and of course the space station's own defence mechanisms, patrolling robots armed with deadly laser beams.

So goes the inlay card. Roughly translated, it means you control a creature in a maze and must collect 12 crystals avoiding the mosnters mentioned above. Trivial, you may think but the

maze is big and the graphics are good.

Mode 1 is used so individual characters are incredibly detailed. The various creatures are superbly animated and all behave in a different way. It will take you a long time to map out the maze and finish the quest.

It may not be the most incredibly original and mind-shatteringly complex game ever devised for a home computer but it is very good fun.

In any case, at £2.99, it must be a bargain. **S.S.**

instructions	80%
playability	70%
graphics	70%
value for money	95%



Ledgeman BBC £2.99

Software Projects, Bearbrand Complex, Allerton Rd, Woolton, Liverpool L25 7SF

After Ledgeman arrives home from the village auction with a Victorian bureau, he decides to dust away the cobwebs and put all his important papers into the top drawer. On opening the second drawer, he is astonished to find a map. The map gives directions to a hidden cave where precious stones can be gathered. However, it also warns you of the strange and perilous guardians of the cave, sentient barrels, meteor storms and host of wondering beasts...

With such a preamble it's an anticlimax to find that Ledgeman is actually a platform and ladders-type game. However, the graphics are good. The

characters are well defined and movement is smooth and flicker-free. Each screen is carefully designed so that you have to collect the jewels in the right order and timing is critical.

I did find that some of the screens were a little too hard but that doesn't detract from the fact that this is a very enjoyable Manic Miner derivative at a very low price. **S.S.**

instructions	70%
playability	75%
graphics	80%
value for money	95%



Steve Davis Snooker 48K Spectrum £7.95

CDS Microsystems, Silver Hse, Silver St, Doncaster, S Yorks DN1 1HL

Following the great success of computerised pool, it seems logical to expect the similar treatment of snooker. This is a fine implementation, with very realistic and predictable movement of the balls, first class sound, with Microspeech if you have the hardware, and excellent graphics.

Set up for joysticks, the cursor is placed at the point you wish to position the cue ball, then moved to the exact point on the target ball. You are then given the opportunity to select power of shot and a cunning device on screen allows spin to be determined by choosing the area of the cue ball to be struck. Press the fire button, and away you go.

Ultra-smooth graphics show all movement realistically, and even the sound of colliding balls is provided. On-screen scoring is given, and provision is made for a one- or two-player game, though you can't play against the computer apparently.

The only thing which spoils it is the dreadful shimmer of the Spectrum's green, which tends to make everything more difficult to see. Very classy, but rather overpriced. **D.M.**

instructions	100%
playability	100%
graphics	100%
value for money	75%



Fast and furious

Arcade action to keep those fingers flying and the cogs of your brain spinning. Take them seriously!

Acid Drops BBC B 2.50

Firbird, Wellington Hse, Upper St Martin's Lane, London WC2H 9DL

Nothing to do with sweets but an acid bath which hangs over you threateningly. Moths, pods and spinners are your enemies sending homeing missiles which are fairly easy to avoid.

You have to shoot the creatures but more important, avoid hitting the acid tank. Not very easy and the acid is soon dripping down with fatal consequences. However, if you stay alive long enough a gate opens up on your right and you can make your escape. Here you fly through a maze of tunnels into the next screen. Incredibly there are nine levels but I found it difficult enough with two!

The keyboard controls were

straightforward until you have to fly. Then I would have preferred the joystick which is optional on this game. Unusual feature was the ability to define the sensitivity of the joystick.

This game is longer than most of Firebird's other offerings being loaded in two parts with good quality musical accompaniment.

I liked it. It was fiendishly clever and good fun offering a surprising variety. Perhaps a little too difficult but good value. **M.P.**

instructions	100%
playability	85%
graphics	90%
value for money	100%



Vampire Killer 48K Spectrum £1.99

Scorpio Gamesworld, 307-313 Corn Exchange, Manchester

Your task is to collect crucifixes, garlic and silver bullets from rooms in the house, shown two stories at a time, use the rather unreliable elevator to ascend, and finally, having collected a wooden stake, kill the vampire before your time runs out.

It's not that straightforward however. The doors to the rooms are closed, and when you open them, a ghoul may give you a fright, or there may be a shaft which returns you to the ground floor rather rapidly! Too many frights and you fail; you may then witness Drac flying from the 12th floor window.

In common with the other Scorpio games, this is very well presented on-screen, with a redefined character set and clever use of colour. It's BASIC with machine code graphics routines.

Though the interior of the rooms, the building and shafts are well done, the character you steer about is rather flickery, which tends to spoil it. Similarly, the game is fairly pedestrian and the unpredictable elevators really annoyed me. There are a number of spelling mistakes on the inlay card and one or two on the screen.

All in all quite good, better than many magazine listings. Don't expect Jet Set Willy though. **D.M.**

instructions	80%
playability	80%
graphics	80%
value for money	100%



with the key value of the first stored note
 70 increment note count by 1
 80 reset T if 100 notes played
 90 play note (call code)
 95,96 delay to establish correct selected tempo
 98 lengthen note if key "N" still held down (auto repeats)
 99 GOTO to 10 if human is tapping out stored notes
 100 for 'auto replay' GOTO next stored note

W D, 3 E flat, E E, R F, 5 F sharp, T G, 6 A flat, Y A, 7 B flat, U B, I C, 9 C sharp, O D, 0 E flat.

Pressing non-decoded keys creates pauses in the music which is essential for satisfying compositions.

Having entered a random sequence of notes, press C and you will be confronted by the

immediately into the "C" mode and your tune is replayed.

With simple hardware (an amplifier) and some relatively simple machine code, it is possible to configure the ZX81 to work as a simple storage organ.

It is a useful and fun compositional aid with which I have managed to produce some very reasonable renditions of popular tunes, and also produce some very weird electronic/ZX81 type composition, which would rival Bartok at his best.

Listing 3 Machine code checker

```
200 LET C=0
202 FOR J=16514 TO 16580
210 PRINT PEEK J;";";
215 LET C=C+1
216 IF C=8 THEN PRINT
217 IF C=8 THEN LET C=0
220 NEXT J
```

Using the program

Note that the ZX printer must not be attached. The program can now be RUN and the screen goes blank. At this point connect the computer mic. socket to a sensitive amplifier (cassette or hi-fi), or alternatively, when the program is running, turn up the TV sound and tune for optimum

Now to test the program, play any note sequence.

select tempo option. Try 0 NEWLINE and your sequence of notes will now be replayed quickly and continuously until you press break.

You can now re-run and enter 100 notes of your own composition by playing the keys. Notes are stored as you play and the previous tune is automatically erased. A short touch of the keys will produce single notes. Holding down a key causes repetition. Play

Listing 4 Assembly listing (plus REM)

```
1 REM 5 - 27;Y * K GOSUB 4
(: COPY ?PIPEEK COPY ( RETURN PI
GOSUB RND ( RETURN $4 NEXT TAN X
XXXXXXXXXXXXXXXXXXXXXXXXXXXXXXXXXXXX
XXXXXXXXXXXXXXXXXXXXXXXXXXXXXXXXXXXX
XXXXXXXXXXXXXXXXXXXXXXXXXXXXXXXXXXXX
XXXXXXXXXXXXXXXXXXXXXXXXXXXXXXXXXXXX
XXXXXXXXXXXXXXXXXXXXXXXXXXXXXXXXXXXX
XXXXXXXXXXXXXXXXXXXXXXXXXXXXXXXXXXXX
XXXXXXXXXXXXXXXXXXXXXXXXXXXXXXXXXXXX
10 REM (*ZX81-ORGAN COPYRIGHT
M.P. BIDDLE 1984
20 REM *POINT HL AT NOTE TABLE
30 REM LD HL.00
40 REM ADD HL.BC
50 REM LD D.00
60 REM LD E.$23
70 REM ADD HL.DE
80 REM *GET KEY PRESSED
90 REM LD A.00
100 REM *SEARCH NOTE TABLE FOR
KEY AND GET FREQUENCY
110 REM LD BC.48
120 REM CPIR
130 REM JR NZ.L1
140 REM *PLAY NOTE
150 REM LD C.255
160 REM LD D.(HL)
170 REM :L2LD B.D
180 REM OUT 255.A
190 REM :L3DJNZ.L3
200 REM LD B.D
210 REM IN B.(C)
220 REM :L4DJNZ.L4
230 REM DEC C
240 REM JR NZ.L2
250 REM :L1RET
260 REM )
270 REM DEFB 0 0 60 224 42 180
55 157 57 126 62 93 58 65 46 50
52 22 0 0 31 202 33 140 34 188
```

Holding down a key will cause auto repeat of that note. The decoded keys are as follows:

3 5 6 7 9 0
 W E R T Y U I O

These are note values for these keys:

carefully at any speed and then use "C" to replay the tune automatically at the tempo you select. Try tapping key "N" to replay the tune note by note.

To save your tune, save the whole program in the normal way. When you reload go

Listing 5 BASIC program

```
5 LET T=0
10 IF INKEY$<" THEN GOTO 10
20 IF INKEY$=" THEN GOTO 20
21 IF INKEY$="C" THEN GOTO 50
22 LET B$=INKEY$
23 IF CODE B$=0 THEN GOTO 10
24 IF B$="N" THEN GOTO 60
25 POKE 16524, CODE B$
26 POKE 16586+T, CODE B$
27 LET T=T+1
28 IF T=100 THEN LET T=T-1
30 LET A=USR (16514)
40 GOTO 10
50 LET T=0
51 PRINT "0= FAST 50=MOD. 100= SLOW "
52 INPUT J
60 POKE 16524, PEEK (16585+T)
70 LET T=T+1
80 IF T=100 THEN LET T=0
90 LET A=USR (16514)
95 FOR I=0 TO J
96 NEXT I
98 IF INKEY$="N" THEN GOTO 90
99 IF B$="N" THEN GOTO 10
100 GOTO 60
```

* * * * *
SAVE...SAVE...SAVE
 * * * * *
DISCOUNT COMPUTERS AND SOFTWARE
 * * * * *
 BBC Model B + Cassette recorder + Five games ...£385
 Acorn Electron£184
 Sinclair Spectrum 48K + six games.....£119.95
 BBC Model B Disc Drive from.....£149.50
 Sinclair QL.....£395
 * * * * *
 Prices include VAT & P&P.
 DISCOUNT SOFTWARE FOR ATARI * BBC *
 * * * * *
 CBM 64 * VIC-20 * SPECTRUM *
 * * * * *
 ORIC 1 * TEXAS 99/4A
 * * * * *
 Send no money. For free list send SAE stating
 machine type to:
 * * * * *
RAMTOPS 47 Broom Land, Levenshulme, Manchester
 M19 2TX or telephone 061-442 5603
 * * * * *

If an advertisement
 is wrong we're here
 to put it right.

If you see an advertisement in the press, in print, on posters or in the cinema which you find unacceptable, write to us at the address below.

The Advertising Standards Authority ✓
 ASA Ltd, Dept 3 Brook House, Torrington Place, London WC1E 7HN

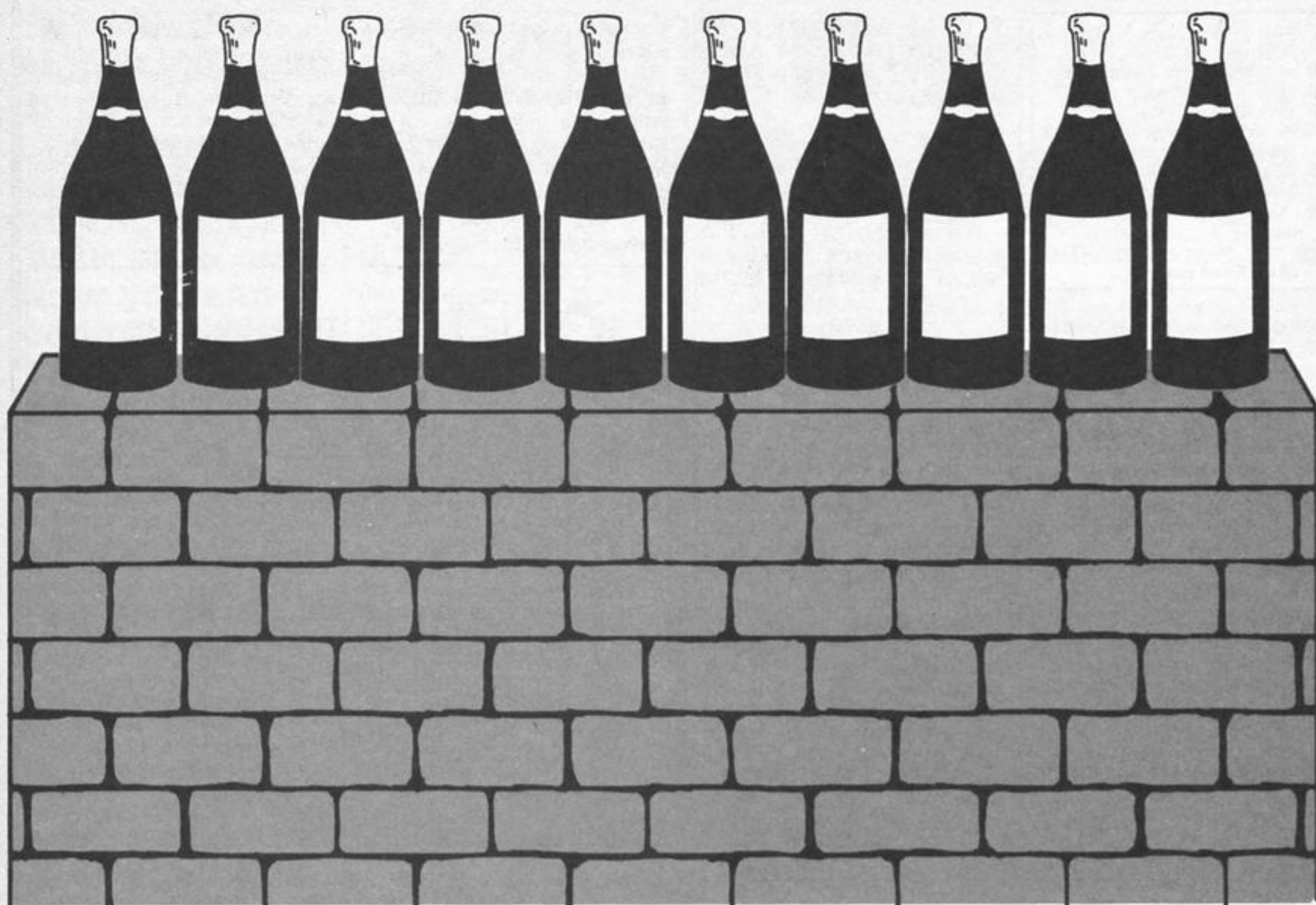

Ten green bottles...

The odds are against you in this game by Tim Jackson. You must try to beat the computer at knocking bottles off walls

There are 21 bottles on a wall. You are an expert at throwing stones. Everytime you throw a stone you hit a bottle.

The computer is just as good as you. Computer and player alternate turns. They may take one, two or three stones each turn. The one left with the final bottle loses the game.

You may like to know you can't win!

How it works

190-270 sets colours and characters
280-310 prints object of game
320-340 press space-bar routines
350-420 sets up game

430-610 asks how many stones player wishes to take
620-670 calculates number of stones computer takes
680-820 lose routine
830-870 print question routine
880-990 smash bottles routine

Variables

WL number of bottles
K key
S number of stones player takes
NS question or information
MS number of stones computer takes
A position of bottle to be smashed
X,D,N,I,G FOR...NEXT loops

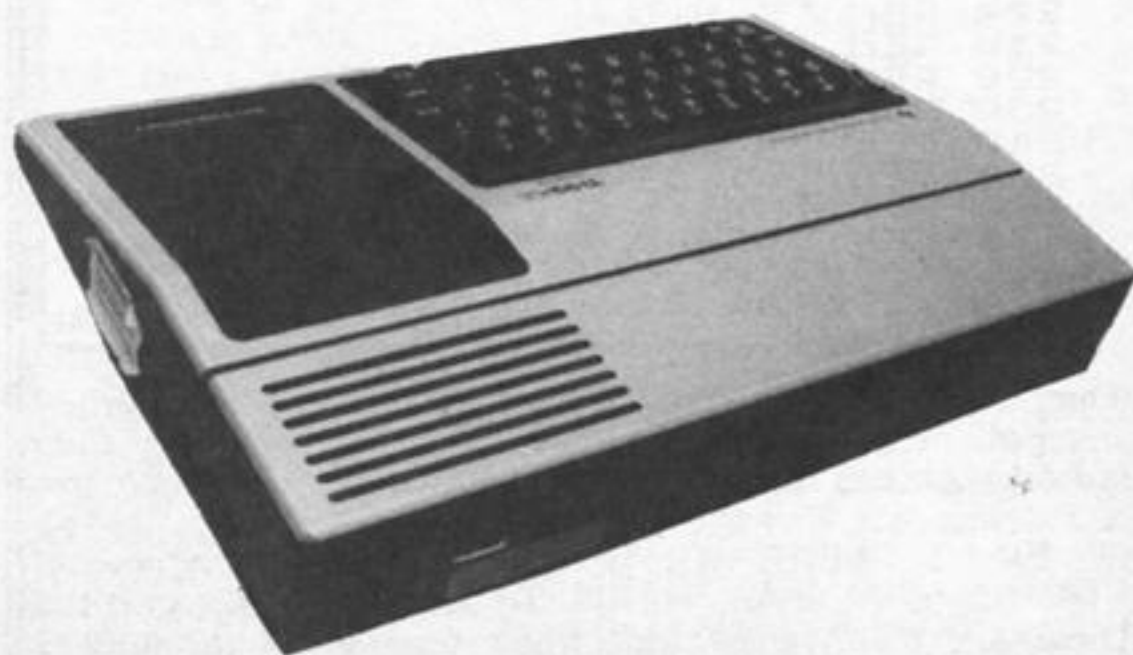

```

100 REM *****
110 REM * BY TIM *
120 REM * JACKSON *
130 REM *****
140 REM *****
150 REM * BRICK A BOTTLE *
160 REM *****
170 CALL CLEAR
180 WL=21
190 CALL SCREEN(4)
200 CALL COLOR(9,7,2)
210 CALL COLOR(10,13,1)
220 CALL CHAR(100,"007F7F7F7F7F7F")
230 CALL CHAR(102,"00FEFEFEFEFEFEFE")
240 CALL CHAR(104,"1818183C7E7E7E7E")
250 CALL CHAR(105,"7E7E7E7E7E7E7E")
260 CALL CHAR(106,"8181C3C3CB8BB8D3D")
270 CALL CHAR(107,"0024421824421842")
280 PRINT " BRICK A BOTTLE OR
THREE": " ~~~~~~
~~~": "THE GAME:-": " ~~~~~~
"
290 PRINT : "THERE ARE 21 BOTTLES
ON A WALL AND YOU ARE EXPERT
AT THROWING STONES, EVERY TIME"
300 PRINT "YOU THROW A STONE YOU
HIT A BOTTLE.": "I'M JUST AS GO
OD.": "WE MAY TAKE 1,2 OR 3 STON
ES EACH TURN."
310 PRINT "WE ALTERNATE TURNS": "
THE ONE WITH THE LAST BOTTLELOSE
S THE GAME": " (PRESS SPACE BAR
TO START)"
320 CALL KEY(0,K,S)
330 IF S=0 THEN 320
340 IF K<>32 THEN 320
350 CALL CLEAR
360 CALL SCREEN(8)
370 PRINT " HHHHHHHHHHHHHHHH
HHHHHH": " I I I I I I I I I I I I I I
I I I I I"
380 FOR X=1 TO 5
390 PRINT "DFDFDFDFDFDFDFDFDFDFDF
DFDFDFDF": "DFDFDFDFDFDFDFDFDFDFDF
DFDFDF"
400 NEXT X
410 N$="HOW MANY DO YOU TAKE"
420 GOSUB 830
430 CALL KEY(0,K,ST)
440 IF ST=0 THEN 430
450 S=1
460 IF K<>49 THEN 490

```

```

470 GOSUB 880
480 GOTO 620
490 S=2
500 IF K<>50 THEN 530
510 GOSUB 880
520 GOTO 620
530 S=3
540 IF K<>51 THEN 570
550 GOSUB 880
560 GOTO 620
570 N$="TAKE 1,2 OR 3"
580 GOSUB 830
590 FOR D=1 TO 500
600 NEXT D
610 GOTO 410
620 MS=4-S
630 N$="I TAKE "&STR$(MS)
640 GOSUB 830
650 S=MS
660 GOSUB 880
670 IF WL>1 THEN 410
680 N$="1 BOTTLE LEFT I WIN !"
690 GOSUB 830
700 CALL SOUND(1000,131,0,165,5,
196,10,-3,28)
710 CALL SOUND(1000,262,0,330,0,
392,0)
720 CALL SOUND(1000,524,0,660,0,
784,0)
730 N$="WANT TO PLAY AGAIN?"
740 GOSUB 830
750 CALL KEY(0,K,ST)
760 IF ST=0 THEN 750
770 IF K=89 THEN 170 ELSE 780
780 N$="BETTER LUCK NEXT TIME"
790 GOSUB 830
800 FOR II=1 TO 500
810 NEXT II
820 END
830 CALL HCHAR(5,1,32,32)
840 FOR N=1 TO LEN(N$)
850 CALL HCHAR(5,4+N,ASC(SEG$(N$,
N,1)))
860 NEXT N
870 RETURN
880 A=31-WL
890 FOR I=1 TO S
900 CALL HCHAR(12,A,107)
910 CALL HCHAR(13,A,106)
920 FOR G=2 TO 30 STEP 2
930 CALL SOUND(100,-5,6)
940 NEXT G
950 CALL VCHAR(12,A,32,2)
960 A=A+1
970 NEXT I
980 WL=WL-S
990 RETURN

```

Mineshaft BBC £7.95

Durell, Castle Lodge, Castle Green, Taunton, Som TA1 4AB

The inlay card starts like this. Your aim is to collect lumps of coal in the 20 rooms of the Mineshaft. Yes, you've guessed, this is a derivative of Manic Miner: 20 screens of platforms connected by conveyor belts and collapsing floors, populated by meanies.

You guide the miner and try to work out a route for him to collect all the lumps of coal in order to escape to the next screen. In the later screen, the lumps are situated in such a way that if you make one false move, you can't finish that screen so there's a lot of tactics, as well as nimble finger movements and critical timing involved.

The characters are nicely

defined and they move smoothly although a little more variety and imagination would have been welcome. The sound effects are slightly irritating and the constant rendition of Green-sleeves in the background can drive you bonkers but can be switched off. In any case, Mineshaft is one of the most enjoyable platform and ladders type games for the Beeb. S.S.

instructions	75%
playability	80%
graphics	80%
value for money	70%



Crypt Capers BBC £2.99

Software Projects, Bearbrand Complex, Allerton Rd, Woolton, Liverpool L25 7SF

Scene is the ancient Egyptian ruins. You have discovered an unknown pyramid buried in the sands of the Sahara. Inside, there are numerous treasures and keys which must be collected to go deeper into the pyramid to reach the Pharaoh.

Each screen consists of a maze with treasures and keys dotted around. Hideous monsters wander around the maze trying to hinder your progress but you can use your gun to shoot anything that gets in the way. You collect all the keys to go onto the next screen. Each one is slightly different and the monsters grow more fierce as you progress.

The characters are well defined and move quickly but smoothly. The sound effects are good too and the general presentation of the game is well up to the standard of other Beeb games.

I must admit that I didn't get very far in this game but this is an addictive game with lasting interest, sold at an incredibly low price. Unless you are a devoted shoot-'em-up fan or an adventure nut, Crypt Capers is recommended. S.S.

instructions	70%
playability	80%
graphics	80%
value for money	100%



Bird Strike BBC B £2.50

Firebird, Wellington Hse, Upper St Martin's La, London WC2H 9DL

Good to see some reasonably priced software for this machine. Does the quality live up to expectations?

Loading was no problem and accompanied by It's a long way to Tipperary just to build atmosphere. This is where Firebird's range wins out; they take care right from the beginning.

When the title screen appears you are told the scene is 'Somewhere in Europe 1914'. A well drawn country scene is set with one or two houses, mountains, clouds above and a churchyard nestling on the right. It's only later that this becomes significant!

Biplanes swoop down on you one at a time dropping bombs. You shoot back from the ground, hit your target and release a carrier pigeon which you also have to prevent from escaping. You can only destroy the planes by a hit dead centre which is hard.

Successive screens are played against the same background but the planes change, becoming increasingly modern. All the action is fast and smooth providing a game of limited scope but well executed. M.P.

instructions	100%
playability	100%
graphics	80%
value for money	100%



Strange worlds

Here is a selection of programs that transport you into some very odd environments. See if you can survive in a pond or creeping through a crypt

Duck! BBC B £2.50

Firebird, Wellington Hse, Upper St, Martin's Lane, London

With tones that remind me of an organ grinder, music is played whilst you load. The scene is set in some antiquated time, when Farmer Tubbs goes out on a duckshoot with his blunderbuss.

The title page with keyboard instructions warns you that 'Sense of Humour is Essential'. You are Farmer Tubbs walking along the bottom of the screen shooting up at a sky full of ducks. You could be forgiven for thinking this was another space invaders variation — it is! A swan occasionally glides across the top of the screen like a mother ship which gives you bonus points for a hit. You have to avoid the dead ducks and when you've cleared the screen

additional hazards present themselves. There are eggs dropping, ducks zig-zagging, all creating a frantic busy scene.

This was one of my favourite games of the shoot-'em-up style. It was easy to make progress initially but became increasingly challenging. It was amusing and quite an original interpretation of an old theme. The music was terrific, although you do have an option to turn it off. Finally, a high score table is included for Sensational Shooters. M.P.

instructions	100%
playability	95%
graphics	95%
value for money	100%



Savage Pond BBC B £7.95

This one has to get an award for its blurb alone. It reminds me of the old 1950's picture trailers: 'Awesome in its conception, brilliant in its depiction'. The leaflet includes a lot more which is of use. Information about the many creatures that occupy the pond is set out clearly. Instructions on how to play are provided and notes on what to expect in the life cycle of the game assuming you survive.

That's what it's all about — survival. You take the part of a tadpole swimming around blissfully eating the amoeba. Suddenly a dragonfly flits across the screen and drops an egg which you eat if you can or else it becomes a creature to devour you. There are several phases which present a challenge to your basic instinct. All of them are realistically presented except perhaps when the radioactive waste is dumped to create the mutated bumble bee.

The graphics are superb giving realistic detail to a host of creatures like beetle larva and bloodworm. The game can be played from the keyboard or with a joystick and the music can be turned on or off.

It requires fast reactions and may prove frustrating to the very young. A good, instructive game for the school, I would have thought. M.P.

instructions	100%
playability	90%
graphics	100%
value for money	100%



Jet Boat BBC £7.95

Software Invasion, 50 Elborough St, Southfields, London SW18 5DN

There's one thing for certain about this, the graphics are amazing. You control a boat which stays in the middle of the screen which scrolls in eight directions, revealing a little more of the landscape as you move.

The object is to manoeuvre the boat so that you finish a course within a time limit. If you manage this, you repeat the process with a shorter time limit and more obstacles. There isn't any flicker and the detail of the objects on the banks is incredible.

The sound effects are good too. However, the playability lets it down badly. Even though the graphics are probably the best

I've seen on the Beeb, the basic concept boils down to moving left and right and avoiding obstacles. There's only one type of course and the general scenery is the same every time. Once you've seen the whole course — which doesn't take long — there's no incentive to go back to it.

Maybe some people would like to buy it just to see the graphics but for the rest, Jet Boat can't be recommended. S.S.

instructions	50%
playability	20%
graphics	100%
value for money	50%



The Nomad of Time CBM 64 £9.95

Mosaic, Baffins La, Chichester, Sussex PO19 1UD

The Nomad of Time is based on the stories by Michael Moorcock about Captain Oswald Bastable. The instructions for your mission are Eyes to the cold — whatever that means. You have 60 days to travel the world and save it.

The game is split into two main sections — you fly between continents in your airship and then land in a country and explore it in the usual adventure game style.

In theory the game sounds good and perhaps it would be if it was faster. As it is the program is unresponsive to the keyboard. In the airship part of the game you have to hold a controlling

key down for a couple of seconds before anything happens. In the adventure game it is possible to type faster than the computer can read the keyboard. It may also take up to 15 seconds to analyse what you entered. I also found a bug in the games input routine.

I would not rate the game very highly because of its slow speed making it unplayable. K.I.

instructions	50%
playability	10%
ease of use	10%
value for money	10%



Yacht Race 48K Spectrum £9.95

Hill MacGibbon, 92 Fleet St, London EC4Y 7JY

To call this merely a game is an insult. It's more like a sailing simulator, with built-in opposition!

First, choose your course, by reference to the printed chart. Then learn to sail! You start with control of the rudder, learning how to use the wind. Next, you learn to manage the boat, and when you can cope with all three simultaneously, you've arrived! You don't have to do it all at once. You can compete against Black Streak using only the rudder if you choose.

There are a number of courses. You can select the number of laps. A constantly updated map shows your location. A 3D animated view over the front of the boat shows the opposition, the lake, shoreline and surrounding features, and market buoys. On-screen displays show speed, wind, direction and heel.

Rather magnificent, with excellent manual and automatic save to Microdrive. Criticisms? It's difficult to distinguish the edge of the shore sometimes, and switching between map and view is a little slow. Generally however, first class quality.

D.M.

instructions	100%
playability	100%
graphics	100%
value for money	80%



Wheels and wings

This selection of games allows you to try out some very difficult forms of transport. You may also find yourself in some sticky situations

3-D Grand Prix BBC £9.95

Software Invasion, 50 Elborough St, Southfields, London SW18 5DN

With the incredible success of Pole Position in the arcades last year, it was quite surprising not to see software houses flocking to convert it for the home micros until now. There's been a sudden surge of 3D racing games for the Beeb. 3-D Grand Prix is one of them.

This is slightly different in that almost half the screen is taken up by the dashboard, rather annoying since it only shows the speed, gear and the handle bars turning round. However, the graphics are still impressive. The cars loom towards you as you try to over take and the road bends and turns realistically. Unfortunately, this game falls down very

badly on playability. Taking over other cars is almost impossible since when you try they take up almost all of the screen! Also, taking bends is far too easy and there's no noticeable skidding.

All in all, this is the best as far as graphics are concerned but falls way behind the official version by Atarisoft when it comes to playability. S.S.

instructions	40%
playability	10%
graphics	100%
value for money	30%



Salvage CBM 64 £6.50

Sumlock Microwave, Royal London Hse, 198 Deansgate M3 3NE

This text/graphics adventure is based on a redundant convict space shuttle. Your mission is to recover the valuable Sequerra Crystal, work out the teleport code and save your life by teleporting off the craft. You will have to overcome many problems and be careful not to get killed by the various traps which are awaiting you.

The game took about five hours to complete. It was found to be both interesting and mind bending in places. Quite a lot of thought and effort went into solving this game one evening. I would recommend it to anyone at all who likes adventures.

A graphical picture and a description is given for every location along with a list of objects and the obvious exits. The graphics are good and the display in general is well laid out and easy to read.

The program has a function which allows you to enter notes on the screen for reference purposes. Loading and saving of your current game on either tape or disc is available — these seem to work correctly. K.I.

instructions	60%
playability	85%
display	80%
value for money	85%



Stretch your mental capacities with this tongue-twister for the mind. R.A. Houlton answers Graham Kendall's questions about 4-D arrays

Recently Graham Kendall wrote about his confusion over 4-D arrays (HCW 86). His problems would seem to arise from a conflict of terminology.

He's right when he states that if we dimension an array using the command DIM A(3,3,3,3,3) the computer will set up 243 locations, but it's wrong to think of this as an array in five dimensions.

It is in fact a one-dimensional set of locations partitioned into a number of subsets. The first partition is into three subsets, each containing 81 locations. Each of these subsets is then further partitioned into three more subsets, each containing 27 locations.

This process eventually leads to 81 subsets, each containing three locations. A call such as A(1,3,2,1,2) indicates to the computer which set to choose at each partition.

It would probably be better to think of a multi-dimensional array as a branching system rather than a geometrical structure, and better still to think of it in terms of sets and subsets.

But what of the geometrical aspect and the fourth dimension? We live in what for us is a three-dimensional world of left and right, up and down and forwards and backwards. The computer's world is uni-dimensional, i.e. backwards and forwards along its memory locations like an engine on a railway line.

By feeding the right combinations of values into these locations it is possible to produce on a TV screen a two-dimensional display. If we mentally accept certain conventions to do with perspective we can produce a two-dimensional representation of a three-dimensional object and code this in a one-dimensional array for the computer.

Is it possible to imagine a four-dimensional object and represent it on a two-dimensional surface such as a page of this magazine? If we accept the Euclidian axioms regarding points, lines, dimensions etc. it is possible to draw up a table containing the known facts about the

This will blow your mind!

DIM	NAME	POINTS	EDGES	SIDES	SOLIDS	HYPER SOLID
0	Point	1				
1	Line	2	1			
2	Square	4	4	1		
3	Cube	8	12	6	1	
4	Hypercube	16	30	24	8	1

Figure 1

construction of an object such as a cube (Fig. 1) Armed with these facts we can try and project what would be the building blocks of a four-dimensional object, which we call a hypercube:

How can we draw a representation of this four-dimensional solid made up of eight cubes, with 24 sides but only 16 corners? We may find a clue in the way we draw a cube. Our three normal dimensions are mutually at right angles but when we draw a cube we accept that one of the dimensions will in fact be at 45 degrees to the other two (Fig. 2)

But since we can accept this

distortion in a number of directions and still make sense of the resultant drawing, why not combine two distortions to provide our fourth dimension? (Fig. 3)

Using these four distorted dimensions it is possible to produce the drawing shown in Fig. 4. At first sight it may not look like an object, but try to remember that the hypercube is outside our normal experience.

Figure 5 breaks down the drawing into the eight constituent cubes and shows which corners, edges and sides are shared. How these could exist together at one and the same time is again

beyond comprehension.

For anyone who is interested in trying to construct a three-dimensional representation of the hypercube, I have included a sketch of a framework (Fig. 6) which you could make out of wire or straws. Remember that this is subject to distortion in the same way as our perspective drawings. All the angles should be right angles, all the sides of equal length and all the cubes of equal size. Furthermore the interconnectedness of the structure is such that if you pass through any face of the large external cube you would find yourself in the small internal

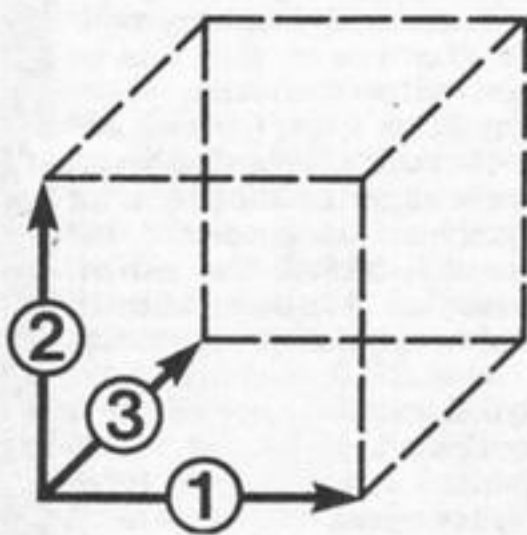

Fig. 2. Normal distortions

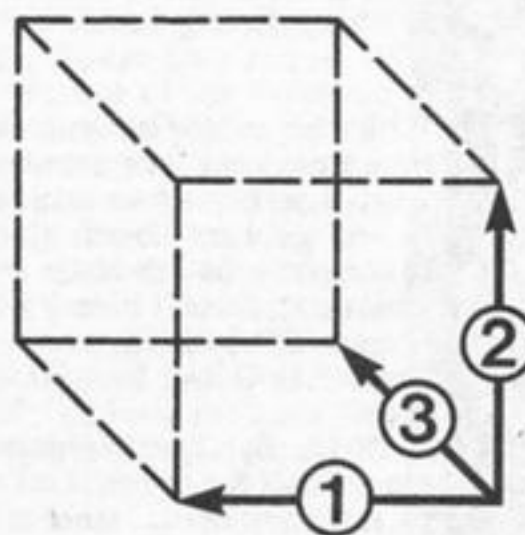

Fig. 3. 4-D distortion

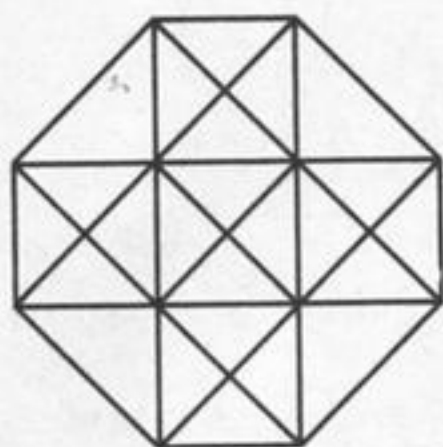
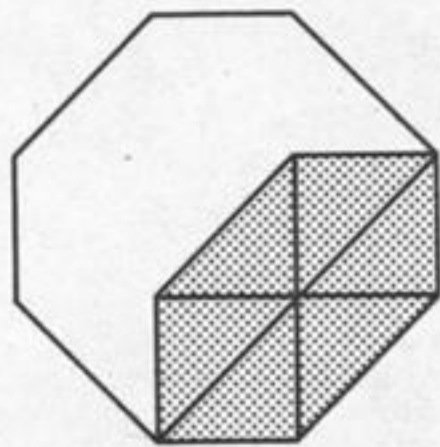
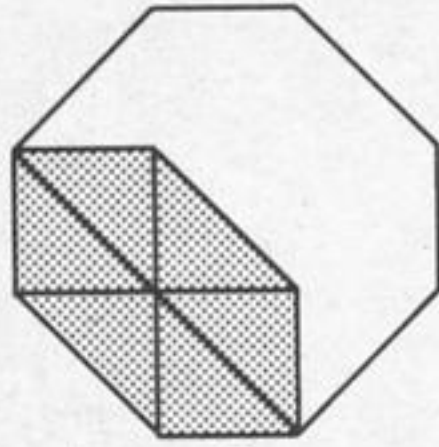

Fig. 4. The hypercube



1



2

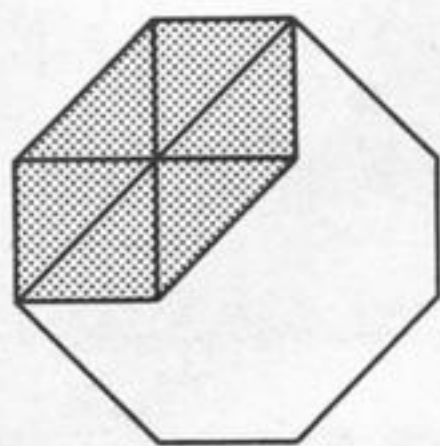

3

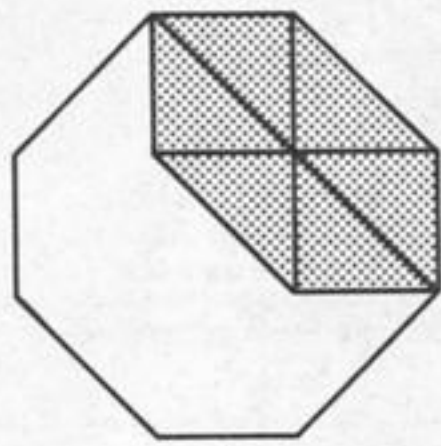

4

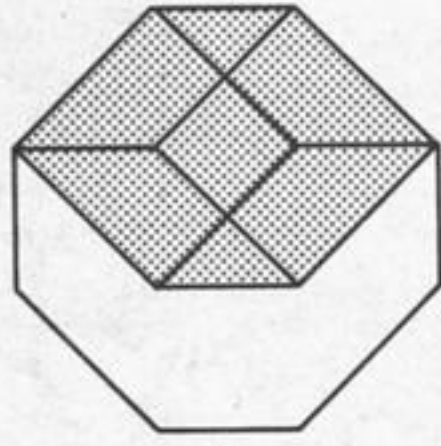

5

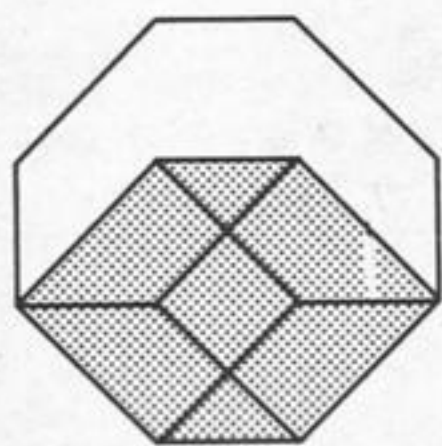

6

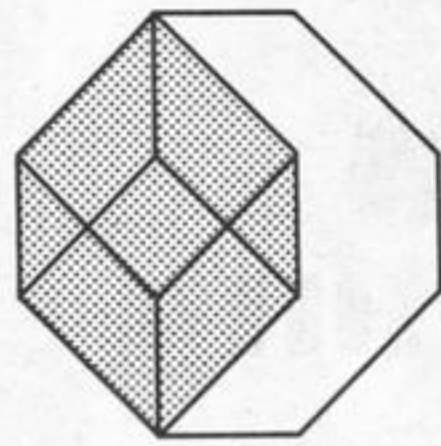

7

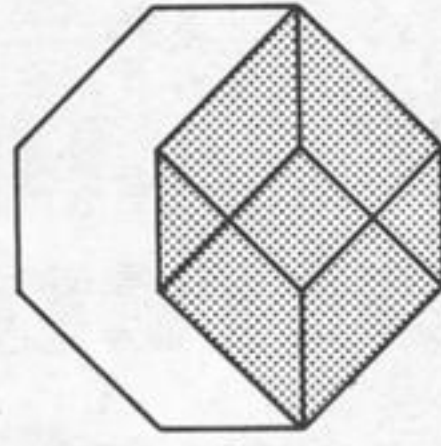

8

Fig. 5. The eight cubes

cube. This is also true of our previous diagram, since each cube is surrounded by six other cubes.

Applications of the computer arrays are fairly obvious. Any situation which requires partitioning of a set of things into discrete subjects is open to the use of arrays. The applications of the geometrical interpretation of the fourth dimension are not so obvious.

Could it be that we have stumbled on the location of the ultimate adventure game in which there are eight rooms, each with six exits but from which there is no escape back to our three-dimensional world?

We said that all eight of the three-dimensional cubes which made up the hypercube existed at one and the same time. The program listing for the Spectrum printed below attempts to give an impression of the hypercube by distorting the time factor.

Type in the program and then RUN it with a PAUSE value of 20. This will show you the positioning of the cubes. Try running the program with smaller PAUSE values and then finally edit out Line 10 and all other lines ending in 5. All letters inside quotation marks should be entered in graphics mode.

```

5 REM HYPERCUBE BY A.HOLLTON
10 INPUT "PAUSE VALUE (1 FAST
20 SLOW ";B
20 FOR I=USR "A" TO USR "L"+7
30 READ A: POKE I,A
40 NEXT I
50 PRINT AT 09,14;"AB "
60 PRINT AT 10,14;"CE "
70 PRINT AT 11,14;"FA "
75 PAUSE B:CLS
80 PRINT AT 09,14;"AHB"
90 PRINT AT 10,14;"BJI"
100 PRINT AT 11,14;" "
105 PAUSE B:CLS
110 PRINT AT 09,14;" AB"
120 PRINT AT 10,14;" CE"
130 PRINT AT 11,14;" FA"
135 PAUSE B:CLS
140 PRINT AT 09,14;" "
150 PRINT AT 10,14;"AHB"
160 PRINT AT 11,14;"BJI"
165 PAUSE B:CLS
170 PRINT AT 09,14;" "
180 PRINT AT 10,14;" AK"
190 PRINT AT 11,14;" GA"
195 PAUSE B:CLS
200 PRINT AT 09,14;" LB"
210 PRINT AT 10,14;" BG"
220 PRINT AT 11,14;" "
225 PAUSE B:CLS
230 PRINT AT 09,14;"AK "
240 PRINT AT 10,14;"GA "
250 PRINT AT 11,14;" "
255 PAUSE B:CLS
260 PRINT AT 09,14;" "
270 PRINT AT 10,14;"LB "
280 PRINT AT 11,14;"BG "
285 PAUSE B:CLS
290 GO TO 50
    
```

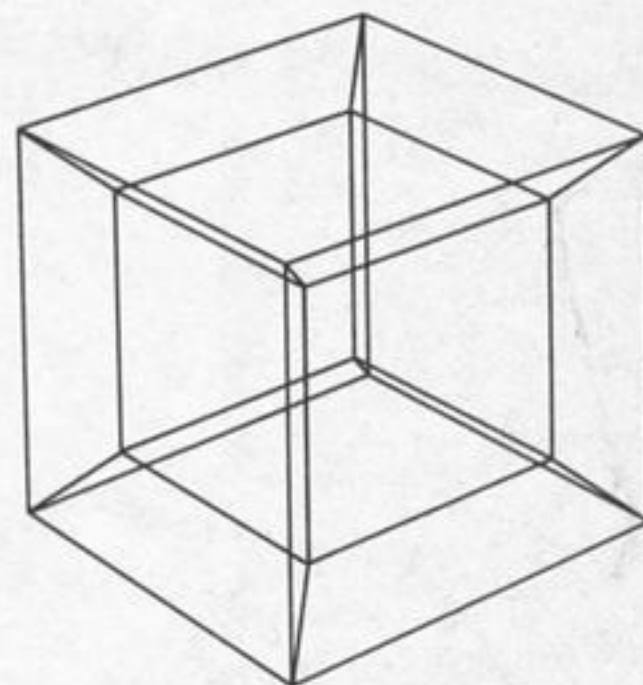

Fig. 6. 3-D framework representing a hypercube

```

300 DATA 1,2,4,8,16,32,64,128
310 DATA 128,64,32,16,8,4,2,1
320 DATA 128,192,160,144,136,13
2,130,129
330 DATA 129,130,132,136,144,15
0,192,128
340 DATA 1,3,5,9,17,33,65,129
350 DATA 129,65,33,17,9,5,3,1
360 DATA 255,129,129,129,129,12
9,129,255
370 DATA 255,64,32,16,8,4,2,1
380 DATA 255,2,4,8,16,32,64,128
390 DATA 1,2,4,8,16,32,64,128,255
400 DATA 255,3,5,9,17,33,65,129
410 DATA 255,192,160,144,136,13
2,130,129
420 REM A B C D E F G H I J K
L
430 REM ENTER IN GRAPHICS CHR$
440 REM "A B C D E F G H I J K
    
```

Computer Cluedo CBM 64 £12.95

Leisure Genius, 3 Montagu Row,
London W1H 1AB

Computer Cluedo is a version of the detective game by Waddingtons. It is a good implementation of a well tried and tested board game.

The object is to solve a murder mystery by specifying who killed Dr Black — found dead at the bottom of the stairs in Tudor Close. The murder weapon and location of the crime must be found. You move from room to room and interrogate the other players. Finally you should eliminate everything except the answers.

The program is extremely user friendly and can't let you do anything wrong or cheat. You may have sound to help add

interest. Other options allow specifying the speed and type of TV set (colour/b&w).

The screen contains nice graphical displays and pictures which make Computer Cluedo a pleasure. Up to six people can play at once. This makes it ideal to amuse the family.

The manual is good and easily understood. No loading problems were encountered and the product has a 12-month warranty. **K.I.**

instructions	75%
playability	85%
graphics	80%
value for money	80%



Here & There BBC £7.95

Mirrorsoft, Holborn Circus,
London EC1P 1DQ

Here & There is a suite of programs designed to teach children about directions and route planning. It revolves around the lovable Mr Men characters familiar to any child.

This package consists of four programs. In Mr Tickle's Jigsaw Puzzle you use the cursor keys to line up small gaps with various parts of Mr Tickle. In Mr Tickle and Mr Grumpy, you guide Mr Tickle's arm towards Mr Grumpy using one letter commands. In Mr Lazy, you guide a worm up a tree towards an apple using commands similar to the previous game. Lastly, in Mr Men Vs Mr Tickle, you have to guide four Mr Men to force back Mr Tickle on a chess board.

All the games feature colourful characters and good animation. Sound is used to good effect. Most important at the end of each game there is always a special bit of cartoon animation or a jingle which certainly gives the child incentive to continue. Although the instructions could have been more comprehensive, this package represents good value for money. After all, it is four games for the price of one. **S.S.**

instructions	70%
ease of use	70%
display	80%
value for money	90%



Frantic Fingers BBC £3.99

Power, 12 Hagley Rd,
Stourbridge, W Midlands DY8
1PS

Do you ever find that the latest game you've bought has the most stupid key configuration you ever dreamt of? Or do you wish that you could play with a joystick rather than keyboard? Frantic Fingers may be the answer. This machine code program allows you to reconfigure the keys or allows joystick control for games only offering key control.

When the main program is loaded, you are given the option to reconfigure the keys or to set up joystick control. You are asked to press the appropriate keys. Once you've done this, you can save a short machine code patch which can be loaded before your main program.

I personally find that the key configuration of all the latest games for the Beeb are well thought out and that keyboard offers more control than the flimsy potentiometer joysticks, so programs of this type aren't needed. The machine code routine only performed its duty with a small minority of the latest commercial arcade games and it is too highly priced. Similar programs have been published in magazines before. **S.S.**

instructions	50%
ease of use	70%
display	50%
value for money	40%



Mind stretching

Here are a few games to make you think. Try these out and test your concentration

Pitman typing BBC £14.95

Pitmansoft, 128 Long Acre,
London WC2E 9AN

Do you ever feel frustrated when typing in listings and wish you could type using all your fingers without mistakes? Pitman Typing may be the answer.

When the disc is booted, comprehensive instructions are printed. After you digest all of it, you can load in the main program to start learning how to type. You are given 12 options, each concentrates on just one aspect of typing. For example, the first concentrates on the home keys.

A picture of the keyboard is drawn and you have to press the key which lights up. You can't continue unless you press correctly. Several other exercises concentrate on a specific part of

the keyboard in a similar fashion. After these, you should be able to feel your way around without looking. Then you go onto the exercises which are given your accuracy rating and typing speed.

Although this is rather expensive, it has been carefully designed and should prove to be useful to those determined to become better typists. **S.S.**

instructions	90%
ease of use	90%
display	80%
value for money	50%



Winning Games on the ZX Spectrum £9.95

Ellis Horwood, Cooper St,
Chichester, Sussex

This is a compendium of no less than 20 games! All unprotected, and written in BASIC. They are very unsophisticated in commercial terms, though they do demonstrate that the sometimes maligned Spectrum Basic can produce acceptable games. The standard is similar to the 'Understanding Your Spectrum' type of book.

Everything under the sun is here; Space Invaders, Breakout, Zombies, Skiing, horse racing, helicopter rescue, fruit-machine, treasure hunt, Lunar Rover, Code Breaker, Blackjack, Duel, a space trader game, balloon flight simulator and six more!

Whilst they are good for BASIC, they are crude in comparison to machine coded games, even those priced at £1.99. You must decide what you want for your money. Is it quality or quantity? For the price of one sophisticated game, you get 20 crude ones! They are reasonable to play, but quickly boring, particularly having seen much better implementations. A large library of different games at low individual cost: for me, the cost doesn't compensate for the lack of sophistication. **D.M.**

instructions	100%
playability	80%
graphics	40%
value for money	55%



A L I E N

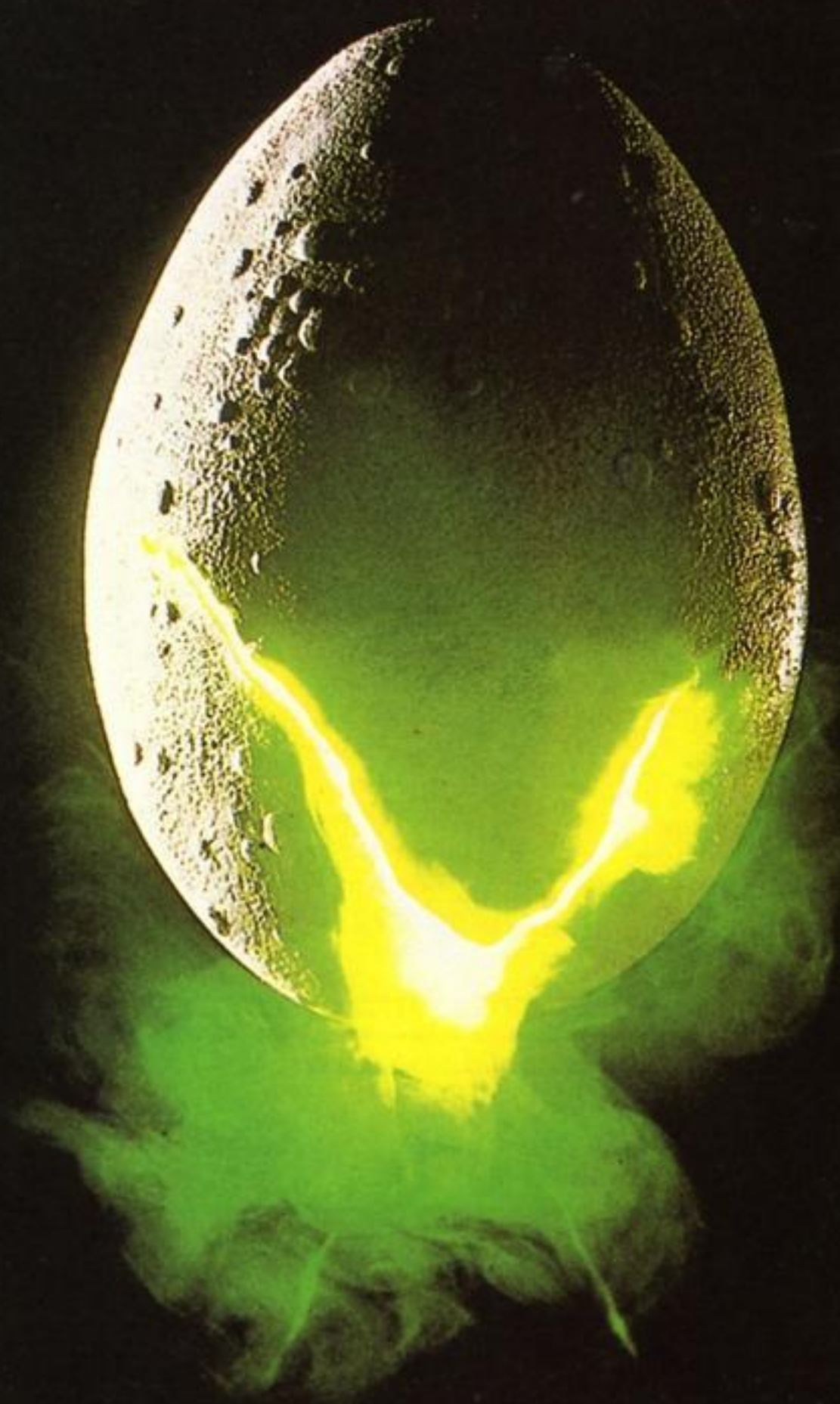

In space no one can hear you scream.



NAVIGATOR
Shy, Skittful and
Intelligent — Panics Easily.

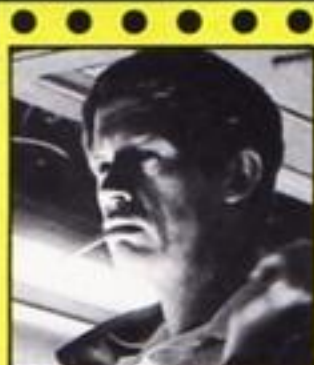

EXECUTIVE OFFICER
Direct, Imaginative,
Cautious, Loyal.

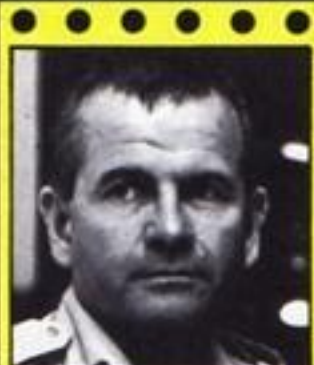

SCIENCE OFFICER
Secretive, Unlikeable, Brilliant —
Occasionally illogical.



CAPTAIN
Solid, Dependable, Courageous —
Excellent Leader.



ENGINEERING OFFICER
Physically Strong, Low I.Q.
Potentially Rebellious



3RD OFFICER
Willful, Ambitious,
Authoritative, Resourceful.

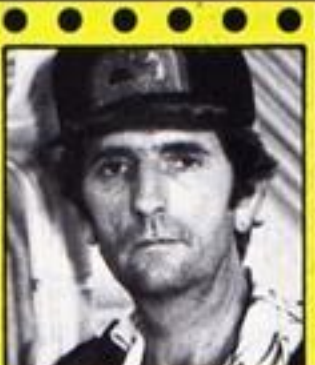

ENGINEERING OFFICER
Cynical, Rebellious,
Untrustworthy, Unflappable.

THE CREW
Personnel
files follow —
yours to
command —
well almost.

MIND GAMES
SPECTRUM 48K · CBM64



Featuring
the unique
Personality Control System

No. 1 Golden Square, London W1R 3AB, Telephone 01-437 0626

£8.99

TOP 20 Gallup

Compiled by

Software

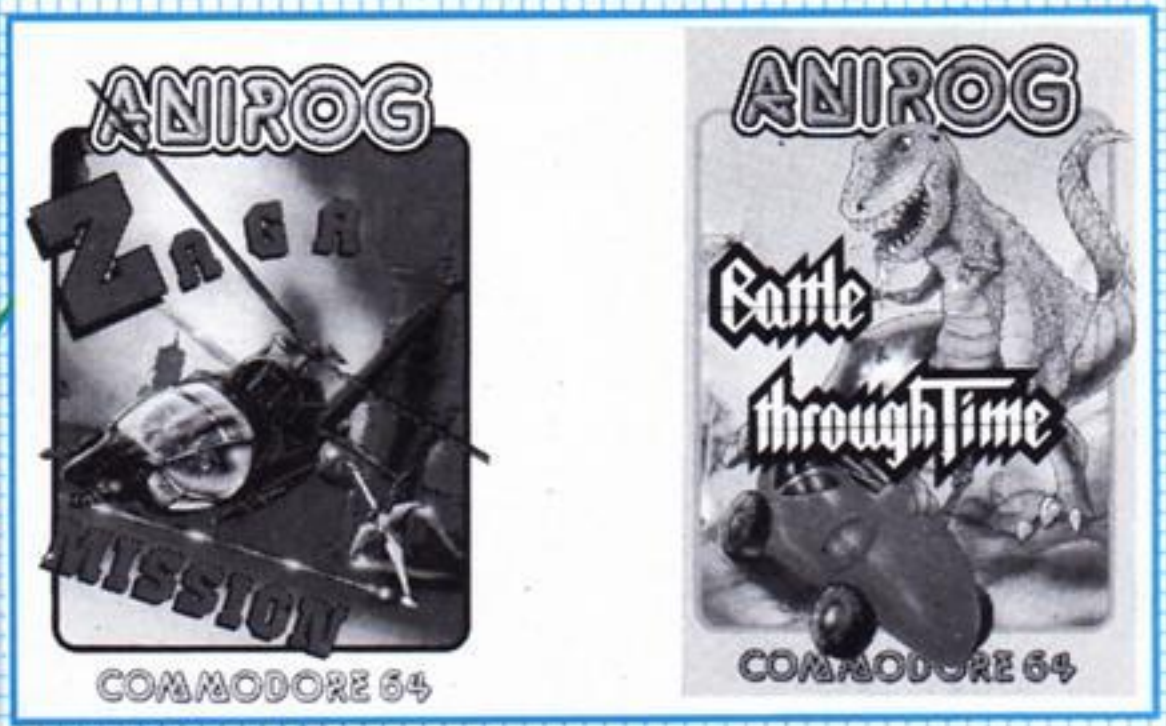

Week Ending December 12, 1984

LAST WEEK	MOVE	THIS WEEK	TITLE	PUBLISHER	SPECTRUM	CBM 64	ELECTRON	AMSTRAD	ATARI	OTHERS
							BBC	VIC-20		
1	●	1	Daley Thompson's Decathlon	Ocean	●	●				
3	▲	2	Ghostbusters	Activision	●	●				
2	▼	3	Booty	Firebird	●	●				
8	▲	4	Pyjamarama	Micro-Gen	●	●			●	
22	▲	5	Match Day	Ocean	●	●				
5	▼	6	Manic Miner	Software Projects	●	●	●		●	●
6	▼	7	Knight Lore	Ultimate	●	●				
12	▲	8	Football Manager	Addictive Games	●	●	●		●	●
16	▲	9	Underwurlde	Ultimate	●	●				
7	▼	10	Elite	Acornsoft			●	●		
4	▼	11	Hunchback	Ocean	●	●	●	●	●	
9	▼	12	Beach-Head	U S Gold	●	●				
15	▲	13	Combat Lynx	Durrell	●	●			●	
14	●	14	American Football	Mind Games	●	●			●	
10	▼	15	Starstrike 3D	Realtime	●	●				
13	▼	16	Jet Set Willy	Software Projects	●	●				
11	▼	17	Skoldaze	Micro Sphere	●	●	●			
20	▲	18	Monty Mole - Wanted	Gremlin Graphics	●	●				
39	▲	19	Fighter Pilot	Digital	●	●				
□	N/E	20	Air Wolf	Elite	●	●				

SPECTRUM

Top Ten

- Daley Thompson's Decathlon
Ocean
- Booty
Firebird
- Match Day
Ocean
- Knight Lore
Ultimate
- Underwurlde
Ultimate
- Pyjamarama
Mikro-Gen
- Starstrike 3D
Realtime
- Skoldaze
Microsphere
- Airwolf
Elite
- Beach-Head
U S Gold

BBC

Top Ten

- Elite
Acornsoft
- Sabre Wulf
Ultimate
- Manic Miner
Software Projects
- Jet Pac
Ultimate
- Football Manager
Addictive
- Frak
Aardvark
- Grand Prix 3D
Software Invasion
- Mr EE
Micro Power
- Scabble
Leisure Genius
- Eddie Kidd Jump Challenge
Martech

COMMODORE

Top Ten

- Ghostbusters
Activision
- Daley Thompson's Decathlon
Ocean
- Raid Over Moscow
U S Gold
- International Football
Commodore
- Combat Lynx
Durrell
- Zaxxon
U S Gold
- Booty
Firebird
- Beach-Head
U S Gold
- Suicide Express
US Gold
- Staff of Karnath
Ultimate

Cuthbert

NOW AVAILABLE FOR THE COMMODORE 16

JUST LOOK WHAT HOME COMPUTING WEEKLY SAYS...

COLOSSAL CAPERS!

OVER 200 CHAMBERS!

5 STAR REVIEW
★★★★★

Reproduced with permission of Home Computing Weekly. Dec. 4th-10th

Post & Packing 50p from

Microdeal, 41 Truro Road, St. Austell, Cornwall PL25 5JE

Credit Card Orders



Phone 0726 73456

Cuthbert Enters the Tombs of Doom
CBM 64 £6.95

Microdeal, 41 Truro Rd, St Austell, Cornwall

The Cuthbert cult continues with colossal capers in the latest escapade from Microdeal. It's a five star game all the way.

The challenge consists of over 200 chambers! How do they do it? Chambers are littered with keys, locks, ghostly ghouls, beastly bats, sadistic saxaphones — yes, saxaphones — sworded spheres, stekevab fiends, transportation chambers and various treasures.

Then there are lamps to be filled to give temporary immunity from the nasties and extra lives to be won and lost. It is quite mind-boggling.

With the cassette comes a join the Cuthbert Club registration, a 16 page instruction booklet — sorry manuscript — autographed poster application with a meet-Cuthbert competition and a key fob. It's superb packaging to go with an excellent piece of software.

The early stages start easily, but the going soon starts to get tough as Oxygen shortages begin to penalise any delay. What's more, negotiating a room once might not be enough, you may have to go back more than once to pick up more keys. But that's enough from me, you'll discover the rest when you buy it. **B.J.**

instructions	92%
playability	95%
graphics	92%
value for money	96%



IT IS QUITE MIND BOGGLING!

EXCELLENT PIECE OF SOFTWARE!

SUPERB PACKAGING

5 STAR REVIEW
★★★★★

BUY IT!

Cuthbert in the Tombs is available from Computer Dealers Nationwide.



Dealers Contact
TWANG WHOLESALE 0734 580200
CENTRESOFT 021 3593020
TIGER TRADER 09 25 55222
LEISURESOFT 0604 46658

HOME COMPUTING WEEKLY CLASSIFIED

Lineage:
35p per word



01-437 0699
EXT 342.

Send your requirements to:
Becki Wilson
ASP LTD.
1 Golden Square,
London W1R 3AB

Semi display: £7.10 per single column centimetre
Ring for information on series bookings discounts.

All advertisements in this section must be prepaid.
Advertisements are accepted subject to the terms and conditions printed on the advertisement rate card (available on request).

Accessories

SOLAR COMPUTER PRODUCTS

Amstrad CPC464 541K with green screen monitor£239.00
Amstrad CPC464 including colour monitor£349.00
BBC Model B£399.00
Commodore 64£198.90
Ferguson TX TV monitor with RGB £229.95

CASSETTE RECORDERS

Amstrad CTR 6100£22.90
Ferguson 3T27£24.90
Amstrad disc drive£199.00

For details write to: P.O. Box 4,
Monmouth, Gwent NP5 4QG, or:
Tel: 0600 860661

Clubs

SPEC PEN PALS UK

Let us put you in touch with others where no one else has reached before. Send s.a.e. for application form and more details to:— A Simmons, 40 Clayburn Circle, Basildon, Essex.

Duplication

jbs records COMPUTER PROGRAMS

REAL-TIME or (Slow) HIGH-SPEED Professional Cassette Duplication and Blanks 1 - 1000+. Computer printed Cassette Labels. BBC Disk Duplication and Unformatted Disks 1 - 500+. Fast security delivery service.

jbs records — a division of
FILTERBOND LTD, 19 Sadlers Way,
Hertford SG14 2DZ 0992-551188

Exhibitions

MICROCOMPUTER EXHIBITION

BROMLEY CIVIC CENTRE
SAT JAN 12
FROM 10 am to 5 pm
ALL THE POPULAR MICROS
HOME — HOBBY — BUSINESS
£1.80 (O.A.P. + UB40 £1.00, Disabled free) BR to BROMLEY NORTH OR BROMLEY SOUTH



For Hire

WIN A COLOUR T.V.

Spectrum - Oric - Atmos

Software Library

FREE MEMBERSHIP —
FREE ENTRY TO DRAW
S.A.E. FOR DETAILS TO:—
HIRE SOFT, 113 BROOMFIELD RD,
MARSH, HUDDERSFIELD (state micro)

To hire a computer from Spectrum 48K upwards, please phone or write to Business & Computer Services, 294a, Caledonian Rd., London N1 1BA Tel. 01 607 0157

QUALITY COMMODORE 64 SOFTWARE LIBRARY

FREE MEMBERSHIP. 60p hire. All brand new titles including Dallas, Zaxxon. Free program every month. Stamp for lists: COMMODORE 64 LIBRARY, 8 FOX ST, TREHARRIS, S WALES CF46 5HE

ORIC, ATMOS, COMMODORE 64, LYNX

Over 150 Oric and 200 Commodore 64 titles.
Stamp for details:—
LES WILSON, 100 BLENHEIM WALK, CORBY, NORTHANTS.

Gifts

T-Shirts and Sweatshirts

Spectrum Invader
I'm User Friendly
Have you seen my Peripherals?
Zap 'em Monster Games
Role players do it in dungeons

100% cotton T-shirts in white or sky £3.50 each inclusive
Poly-cotton Sweatshirts in grey £5.99 each inclusive, small, medium, large and extra large sizes.

Mail Order only from:

One Per Cent Screens, Unit 12, Star Lane Estate, Great Wakering, Essex.

Hardware

CBM 64 VIC-20

TAPE TRANSFER —
DUAL CASSETTE INTERFACE

It is quick and easy to transfer any cassette program with TRIGSOFT's DCL 1 interface. Duplicates all turbos, m/code, data files etc. If a program can be loaded it will be transferred exactly on a second dataset. Send £10.00 inc p&p to: Trigsoft, Marshfield House, 4 Burnett Place, Bradford BD5 9LX
7 day money back guarantee
if not 100% satisfied

Libraries

BBC B/Electron/Dragon software library — Membership £5.00. — Tapes 1 (+30p P&P). Stamp for details. E. Tucker, (H) 58, Blenheim Walk, Corby, Northants.

WANT TO BUY, SELL, SWOP?
PHONE BECKI ON
01-437-0699

Software

SPECTRUM software sale. Up to 60% off RRP. Write for list. Bargain Bytes, P.O. Box 7, Goole, Yorkshire DN14 5RG

Software Games

STAINLESS SOFTWARE for the TI-99/4A only

The longest established supplier of third party cassette software. Over 100 programs, games & utilities, including 24 with 5 star reviews. Quality Programs, reasonable prices (MAIL ORDER ONLY)
For large catalogue, please send a large S.A.E. to:

STAINLESS SOFTWARE,
10 Alstone Rd, Stockport,
Cheshire SK4 5AH

WD Software

Utilities for the QL (£10 on Microdrive)

This package offers single-key loading, running or deletion of files, multiple formatting of cartridges, and auto backup of files from one or more cartridges to another with optional over-writing of namesakes. In addition, a directory of 60+ files can be viewed without screen overflow. NB a VERIFY program is unnecessary — QDOS does this automatically. Now includes directory print-out and "qprint" to print any or all files on a cartridge with optional dated titles. Owners of the earlier package can update by sending OUR cartridge and 25p.

Current Spectrum Software Tradewind (£5 Cassette)

Buy a ship, provisions and cargoes to trade between the harbours of the Coral Islands. Make a fortune if the weather and pirates let you live long enough to master seamanship and economics. A strategy/adventure game with graphics for 48K.

Jersey Quest (£5 Cassette)

Following an accident, you are stranded in the labyrinth of time and must find your own way back to the Present with the aid of persons and objects from Jersey Folklore. Meet the Black Horse of St Ouen, the Dragon and Knight of La Hougue Bie, the Black Cat of Carrefour a Cendre, the Witches of Rocqueburg and many others. A text-only adventure for 48K in machine code (Quill).

Morse Tutor (£4 Cassette)

This one has it all! 4-19 words/minute, variable spacing, variable number of groups of random letters, numbers or mixed, random sentences, own message, single characters (including punctuation), variable pitch, FEEDBACK via screen, printer or SPEECH (phonetic alphabet via Currah u-Speech on 48K version only), and repeat facility. Takes you to and beyond RYA and Amateur Radio receiving standards. 16K and 48K versions on one cassette, 48K only on Microdrive cartridge.

Spectrum Programs on Microdrive

All the above are available on Microdrive cartridges at a price of £4.50 for one cartridge + the price of each program as shown above e.g. a cartridge with Tradewind and Morse Tutor would be £13.50. As a bonus, Gavin Monk's Indexed Loader is included free with each cartridge.

available from

WD Software (H), Hilltop, St Mary, Jersey, C.I.
Tel (0534) 81392

PSYCHEDELIA

PSYCHEDELIA - A STEP BEYOND GAMES

YOU CANNOT WIN
YOU CANNOT LOSE
ONLY ENJOY

PSYCHEDELIA — BEYOND COMPETITIVENESS

THERE IS NO FRUSTRATION
THERE IS NO KILLING
ONLY PLEASURE!

PSYCHEDELIA — AN ENTERTAINMENT

SWITCH ON TO MUSIC
SWITCH ON IN THE DARK
ONLY SWITCH ON!

PSYCHEDELIA — A DANCE WITH RAINBOWS

Jeff



Minter

Lomasoft

ORIGINAL SOFTWARE DESIGN

49 MOUNT PLEASANT, TADLEY, BASINGSTOKE, HANTS.

AVAILABLE FOR CBM 64, C 16, VIC 20

SHORTLY AVAILABLE FOR ATARI, SPECTRUM, AMSTRAD

The Fight Continues... On The Spectrum.

**NOW
AVAILABLE
ON THE
48K
SPECTRUM**



... Earth is threatened by an Empire Deathstar, can you penetrate its defences, destroy it before it destroys you?
... Deathstar Interceptor gives you 12 screens of 3D graphics, super smooth 3D animation, unbelievable sound effects, music, 4 skill levels and a high score table ... this is the ultimate challenge!

... This game has to be played to be believed! You have not seen what the 48K Spectrum is capable of until you have played Deathstar Interceptor!

Available now at £17.95

**Also available for
CBM £19.99**

HOW TO ORDER

To purchase Deathstar Interceptor, simply fill your name and address on a piece of paper, enclosing your cheque/P.O. made payable to: SYSTEM 3 SOFTWARE, and post to the address below. Please allow 7 to 14 days for delivery.

OVERSEAS ORDERS

Please add £1.00 per game ordered.

System 3 Software

South Bank House, Black Prince Road, London SE1
Tel: (01) 587 0873